

Operating Instructions

D2-AVEO

DKL
YOUR DENTAL UNIT

Manufacturer:
DKL CHAIRS GmbH
An der Ziegelei 3
D-37124 Rosdorf
Germany
+49 (0)551-50060
info@dkl.de
www.dkl.de



Form no. GEN-D2AVEO
Rev. 08 / 01.04.2024
Subject to change without notice







Contents

Symbols in the Operating Instructions	3
Symbols inside the Unit	4
Introduction	5
Electromagnetic Compatibility (EMC)	6
Safety Notes - General	7
Safety Notes – Doctor’s Device, Assistant’s Device, Water Unit	8
Safety Notes – Transmission Instruments	8
Technical Specifications	9
Media Requirements	10
Dimensions in Millimetres	12
Product Description	13
Foot Controller	15
Icons – Display	16
Icons – Navigation Touch Display	17
Icons – Setup	18
Moving the Treatment Chair	19
Putting the Treatment Unit into Operation	21
Creating a User	22
Managing Users	23
Main Menu Instruments	23
General Instrument Functions	24
Starting the Turbine	26
Starting the Turbine (Advanced Air)	26
Starting the Electric Motor	27
Starting the Piezo Scaler	29
Function Syringe Luzzani Minilight	30
Implantmed W&H EM-19LC	31
Operating Lamp LED.light EVA	37
Tray	40
Cuspidor	41
Suction	42
Suction System	43
Cleaning and Disinfection of the Suction Handpieces	44
Cleaning and Disinfection of the Suction System	46
Cleaning and Disinfection of the Surfaces	48
Cleaning and Disinfection of the Instrument Holders	51
Check for Oil Residues in the Turbine Return Air	51
Water Separation Unit (WSU)	52
Flushing Function with the Water Separation Unit (WSU)	54
Intensive Flushing with the Water Separation Unit (WSU)	55
Filling DK-DOX 150 into the Water Separation Unit	56
Setting Media Instruments	57
Maintenance and Inspection	58
Safety Inspections	58
Error Messages	59
Warranty Declaration + Waste Disposal	61
EMC - Manufacturer’s Declaration	62













Annex

- > Instructions for Use W&H Dentalwerk Bürmoos GmbH Electric motor EM-12L
- > Instructions for Use W&H Dentalwerk Bürmoos GmbH Implantmed motor EM-19LC
- > Instructions for Use W&H Dentalwerk Bürmoos GmbH Piezo Scaler PB 5
- > Instructions for Use W&H Dentalwerk Bürmoos GmbH FOOT CONTROL S-NW
- > Instructions for Use W&H Dentalwerk Bürmoos GmbH Peristaltic pump
- > Operating Instructions DÜRR Dental Spittoon valve 3
- > Operating Instructions DÜRR Dental CAS 1 Combi-Separator
- > Operating Instructions DÜRR Dental CS 1 Combi-Sepamatic
- > Use Manual Syringe Luzzani Minilight
- > USER MANUAL FARO EVA

Symbols in the Operating Instructions

	WARNING! (risk of injury)		CAUTION! (to prevent damage occurring)		General explanations, without risk to persons or objects
	Thermodisinfectable		Sterilisable up to the specified temperature		Call customer service!

Symbols on the unit

	Consult instructions for use or consult electronic instructions for use		ON / OFF		Do not dispose of with household waste
	CE-marking with identification number of the notified body		Foot controller		Type B application part
	Manufacturing date		Model (designation)		Serial number
	Manufacturer		Medical device		UDI - Product Identification
V	Electrical voltage	AC	Alternating current	VA	Electrical power consumption
A	Current intensity	Hz	Frequency of alternating current		
	Electrical fuse				

Symbols inside the Unit



Earth conductor connection -
Protective earth



Functional
earth

N

Connection point for
neutral conductor

Symbols on the packaging

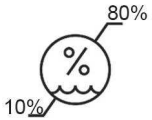

Air humidity, limitation

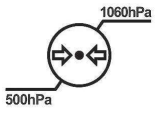

Atmospheric pressure limitation

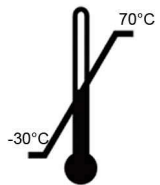

Permissible temperature range



Transport upright; top



Protect from moisture!

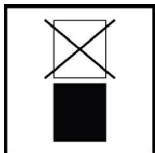

Do not stack!



Fragile

Introduction



For your safety and the safety of your patients

These operating instructions are intended to explain how to use your product. However, we must also warn of possible dangerous situations. Your safety, the safety of your team and, of course, the safety of your patients are very important to us.

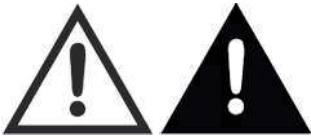

Please observe the safety instructions!

Intended purpose

This treatment unit is used for the diagnosis and therapy of children and adults in the field of dentistry.

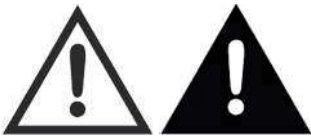

Improper use can damage the treatment unit and thus pose risks and hazards to the patient, user and third parties.

Qualification of the user

The DKL treatment unit may only be used after medically, professionally and practically trained personnel have been instructed. The development and design of the treatment unit were geared towards the target group of dentists, dental hygienists, qualified dental employees (prophylaxis) and dental assistants.



Production according to EU directive
The medical device complies with the provisions of regulation (EU) 2017/745.



Responsibility of the manufacturer

The manufacturer can only be held responsible for the impact on the safety, reliability and performance of the treatment unit if the following instructions are observed:

- > The dental unit must be used in accordance with these operating instructions.
- > If assembly, additions, new settings, changes or repair work is carried out by DKL or trained technicians authorised by DKL or personnel of authorized dealers trained by DKL.
- > The electrical installation of the room must comply with the regulations of the IEC 60364-7-710 standard („Erection of electrical installations in rooms used for medical purposes“) or comply with the regulations applicable in your country.
- > The recommended annual maintenance is carried out and any repair work in this context meets the requirements of EN 62353.
- > „Repeat tests and pre-commissioning tests of medical electrical equipment and systems – general regulations“ are fully complied with.
- > The national legal regulations are observed when using the device, in particular the applicable health and safety regulations and accident prevention measures.

Electromagnetic Compatibility (EMC)



Medical electrical equipment is subject to special precautions with regard to EMC and must be installed and commissioned in accordance with the EMC instructions. DKL guarantees that the dental unit complies with the EMC guidelines only if original DKL accessories and spare parts are used. The use of accessories and spare parts not approved by DKL may lead to an increased emission of electromagnetic interference or to a reduced resistance to electromagnetic interference.



The EMC manufacturer declaration can be found on page 62.



HF communication equipment

Do not use portable and mobile HF-communication equipment (such as mobile telephones) during operation. These can affect medical electrical devices.



Risks due to electromagnetic fields

The functionality of implantable systems, such as cardiac pacemakers and implantable cardioverter defibrillators (ICD), can be influenced by electric, magnetic and electromagnetic fields.

- > Before using the product, ask the patient and user about implanted systems and check the use.
- > Perform a risk-benefit analysis.
- > Do not place the product near implanted systems.
- > Do not place the instruments on the patient's body.
- > Take appropriate emergency precautions and respond immediately to health changes.
- > Symptoms such as increased heart rate, irregular pulse, and dizziness may be signs of problems with a pacemaker or ICD.

Safety Notes – General



- > Before being put into initial operation, the treatment unit must be kept at room temperature for 24 hours.
 - > Before each application, check the treatment unit and the instruments with cables for damage and loose parts.
- 
- > Do not operate the treatment unit if it is damaged.
 - > Check the set parameters each time you restart the unit.
 - > Carry out a test run before each application.
 - > The application and timely shutdown of the system is the user's responsibility.
 - > Make sure that in the event of a device or instrument failure, the treatment can be completed safely.
 - > Use only original DKL fuses.
 - > Never touch the patient and the electrical connection at the treatment unit at the same time.
 - > Do not lean on the doctor's device, the assistant's device, the tray or the operating lamp.
 - > When moving the treatment chair, the doctor's device, the assistant's device, the tray or the operating lamp, pay attention to the patient and the practice personnel.
 - > Always switch off the treatment unit before leaving the practice.



Hygiene and care before using the device

- > Clean and disinfect the device immediately before or after each treatment!
- > Wear protective clothing.



Observe your country-specific guidelines, standards and specifications for cleaning, disinfection and sterilisation.



The treatment unit is classified as an „ordinary device“ (closed device without protection against water ingress).



The treatment unit is not suitable for use in an explosive atmosphere or in explosive mixtures of anaesthetics with oxygen or nitrous oxide.



The treatment unit is not suitable for use in rooms with an oxygen enriched atmosphere.

Safety Notes – Patient Chair



- > Not suitable for patients who cannot remain in a resting position due to mental or physical disabilities.
- > The patient's arms and legs must rest on the upholstered parts of the chair.
- > Do not exceed the maximum patient weight of 150 kg.
- > Do not sit on the head or foot rest of the horizontally aligned patient chair.
- > Position changes must always be carried out under the surveillance of the person giving treatment.
- > Watch patients while moving the treatment chair.
- > Make sure that there are no objects under the treatment chair.

Safety Notes – Doctor’s Device, Assistant’s Device, Water Unit



- > Before putting the device into initial operation and after downtimes (weekends, (public) holidays etc.), flush the water lines intensively.
- > Flush all instrument connections for 2 minutes before starting work.
- > Press the glass fill button several times before starting work.
- > Rinse used instruments for 20 seconds after each treatment.



Risk of injury or infection caused by instruments that are not in use:
The arrangement of the instruments may cause injury or infection to the hand and forearm when accessing the tray or the display.
Therefore, when accessing the tray or the display, pay attention to the arrangement of the instruments.



Highly immunosuppressed patients or patients with specific lung diseases should not get into contact with the water of the treatment unit.
It is recommended to use sterile solutions.



Never touch the USB plug below the doctor’s device and the patient at the same time.



- > Do not exceed the maximum permissible load of 2 kg on the doctor’s device and on the assistant’s device.
- > If you have a mobile doctor’s device as a cart version, avoid driving over objects on the ground when moving the cart. If there is strong resistance, the doctor’s device could tip over.

Safety Notes – Transmission Instruments



Follow the instructions and safety notes in the operating instructions for the transmission instruments.

- > For the motors, only use transmission instruments with transmission systems that are ISO 3964 (DIN 13940) compatible and approved by the manufacturer.
- > For air-powered instruments, only use coupling systems according to ISO 9168.
- > For air-powered instruments, only use coupling systems with anti-retraction stop for contaminated cooling water.
- > Observe the information provided by the manufacturer of transmission instruments regarding transmission ratio, maximum speed and maximum torque.
- > Only use faultless instruments and with the motors pay attention to the direction of rotation of the rotating instrument. Follow the manufacturer’s instructions.
- > Plug in the transmission instrument only when the device is at a standstill.
- > If the coolant supply fails, switch off the transmission instrument immediately.
- > Before each use, check the transmission instrument for damage and loose parts.
- > Never operate the clamping mechanism of the transmission instrument while using the device or while the device is running down.
- > Never reach into the instrument while it is running or running down.
- > Avoid overheating of the treatment site.
- > Check the secure placement of the instrument.

Technical Specifications



The motors of the treatment unit are designed for intermittent operation in accordance with the dental treatment method.

Driving motors for patient chair and backrest: duty cycle (max. 25 s „ON“ / 400 s „OFF“).

Supply voltage	230V AC
Nominal voltage	max. 3 A
Frequency	50/60 Hz
Fuse	T 6.3 A H 250 V primary
Maximum power consumption	625 VA
Device class according to MDR (EU) 2017/745	Ila
Protection class	Device of protection class I
Application parts	Type B application parts
Contamination level	2
Over voltage category	II
Power cable	3x1,5 mm ²
Suction control lines to the suction device	5x1,5 mm ²
Potential equalisation	1x 4 mm ²
Relay control line optional special function	3x1,5 mm ²
Free end electrical cables above floor	500 mm
Fuse for domestic installation	Circuit breaker: 16 A medium-lag Recommendation: circuit breaker type C
Degree of protection against ingress of water	Ordinary device (without protection against water ingress). The foot control is waterproof according to protection class IPX8.



Permanently connected device. In order to avoid the risk of electric shock, this device may only be connected to a power supply with an earth conductor.

Weight	
D2-AVEO with floor mounting plate	max. 265 kg
D2-AVEO without floor mounting plate	max. 240 kg

Transport and storage conditions	
Ambient temperature	-30 to +70 °C
Relative humidity	10 to 80 %
Atmospheric pressure	500 hPa to 1060 hPa

Operating conditions	
Quality and load-bearing capacity of the floor	The floor must be level and horizontal according to EN 18202. Unevenness of the floor along the total length of the chair base up to 2 mm is acceptable. The minimum load-bearing capacity of the floor must be 0.5 N/cm ² (equivalent to approx. 500 kg/m ²).
Ambient temperature	10 to 35 °C
Relative humidity	15 to 80 %
Atmospheric pressure	700 hPa to 1060 hPa
Installation site	≤ 3,000 m above sea level The treatment unit is not suitable for operation in hazardous areas.

Media Requirements

Media water	
Water hardness	1.5 to 2.14 mmol/l = 8,4-12 dH
ph-value	6,5 to 8,5
Water filtration on site	≤ 100 µm
Water inflow	Pipe 10x1mm, angle valve outlet 3/8"
Water connection above floor	min. 40 mm, max. 60 mm
Water inlet pressure	2.0 to max. 6.0 bars
Water quality	Cold water in accordance with local and national drinking water regulations.
Minimum flow rate	3 l/min

- Perform the installation according to the national installation requirements (e.g. EN 1717).
- For the reduction of microorganisms in the water supply pipe, please observe the following when laying this pipe to the treatment unit:
 - Avoid long stub lines to the treatment unit.
 - Select the installation in such a way that other essential consumers (e.g. washbasin) are as far as possible behind the connection of the treatment unit can be supplied from the same pipe.
 - Avoid laying the hot water supply pipes in parallel.
- Recommendation: For the water supply of the treatment unit, install an angle valve with 2 outlets and 2 stop cocks. The second outlet allows easy sampling of water for microbiological analysis.

Connection to the public drinking water supply

The treatment unit with a water separation unit complies with the requirements of EN 1717 (free outlet with separation distance ≥ 20 mm) and the DVGW (German Technical and Scientific Association for Gas and Water). It is intrinsically safe in accordance with worksheet W540 and therefore also meets the requirements of W270 and KTW (guideline for hygienic assessment of organic materials in contact with drinking water).

When the treatment unit is equipped with a cuspidor, the bowl rinser ensures the free outlet with a separation distance ≥ 20 mm.



Before the treatment unit is installed, the microbiologically perfect water quality of the domestic water supply should be ensured and documented in the form of a microbial count. Sampling and microbial count should be carried out by a competent laboratory.

Media air	
Air inlet pressure	max. 7 bars
Air consumption	80 NI/min
On-site air filtration	≤ 100 particles size 1 - 5 µm referred to one m ³ of air
Oil content	≤ 0.5mg/m ³ , oil-free compressors; the compressor must suck in hygienically perfect air.
Humidity	Pressure dew point ≤ -20 °C at atmospheric pressure
Compressed air supply	Pipe 10x1 mm, angle valve outlet 3/8"
Air connection above the floor	min. 40 mm, max. 60 mm



Clean air and water pipes before installing the unit.

Chips and other foreign substances could be flushed or blown into the treatment unit.

Metal chips can interfere with the function of pneumatic components. Filters are clogged by foreign substances.

- When assembling, make sure that there are no chips or other foreign substances in the pipes.
- Flush the water pipes.
- Blow out the air ducts.
- Make sure that no further foreign substances get into the pipes and ducts after rinsing or blowing out.

Media Requirements

Requirements for the suction system	
Vacuum at supply connection	min. 0,12 bar, max. 0,18 bar
Minimum suction power at supply connection	≥750NI/min
Suction system	Type 1: high flow rate wet or dry suction
Diameter of suction handpieces:	small suction handpiece: 6 mm large suction handpiece: 16 mm
Suction pipe	DN40 HT-PP (polypropylene, inside diameter approx. 36.5 mm)
Water drain	DN40 HT-PP (polypropylene, inside diameter approx. 36.5 mm)
Gradient	Min. 10 mm per metre
Wastewater volume	3 l/min

Filter in the treatment unit		maintenance interval	Article number
Particle filter water inlet	80 µm	Replace annually	200095-E2
Particle filter compressed air inlet	50 µm	Replace annually	200095-E1
Solid particle filter for the suction system	Mesh size 1 mm	In case of damage, replace at least annually.	514100

Typical pressure in the suction system

Spray mist suction	Vacuum / mbar
90 NL/min	22,6
150 NL/min	38,2
200 NL/min	60,0
250 NL/min	88,8
300 NL/min	124
316 NL/min	137
Saliva ejector	
50 NL/min	100,0
55 NL/min	120,0
60 NL/min	135,2
67 NL/min	162
80 NL/min	200

Requirements for Supply Connections

①	Air: pipe min. 10x1 mm, angle valve outlet 3/8"
②	Water drain DN40 HT-PP
③	Suction line DN40 HT-PP
④	Power cable 3x1.5 mm ²
④	Equipotential bonding 1x 4 mm ²
④	Control line to suction device 5x1.5 mm ²
⑤	Water: pipe min. 10x1 mm, angle valve outlet 3/8" (2 outlets with 2 stopcocks)

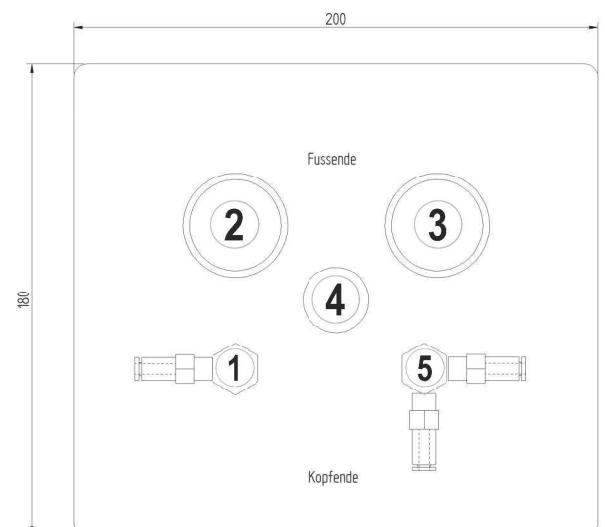

Dimensions in Millimetres

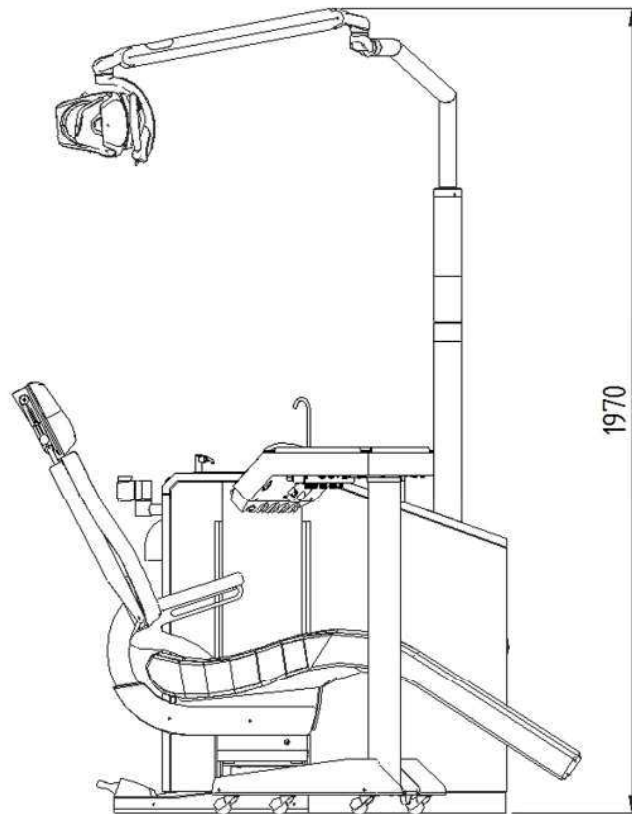
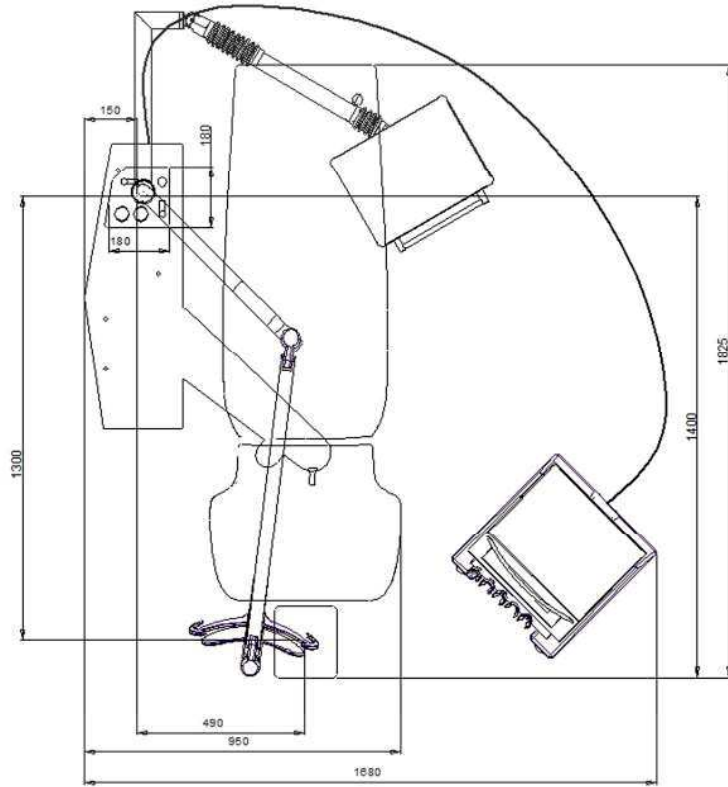

Treatment chair:
lowest position 370 mm
highest position 880 mm

Product Description

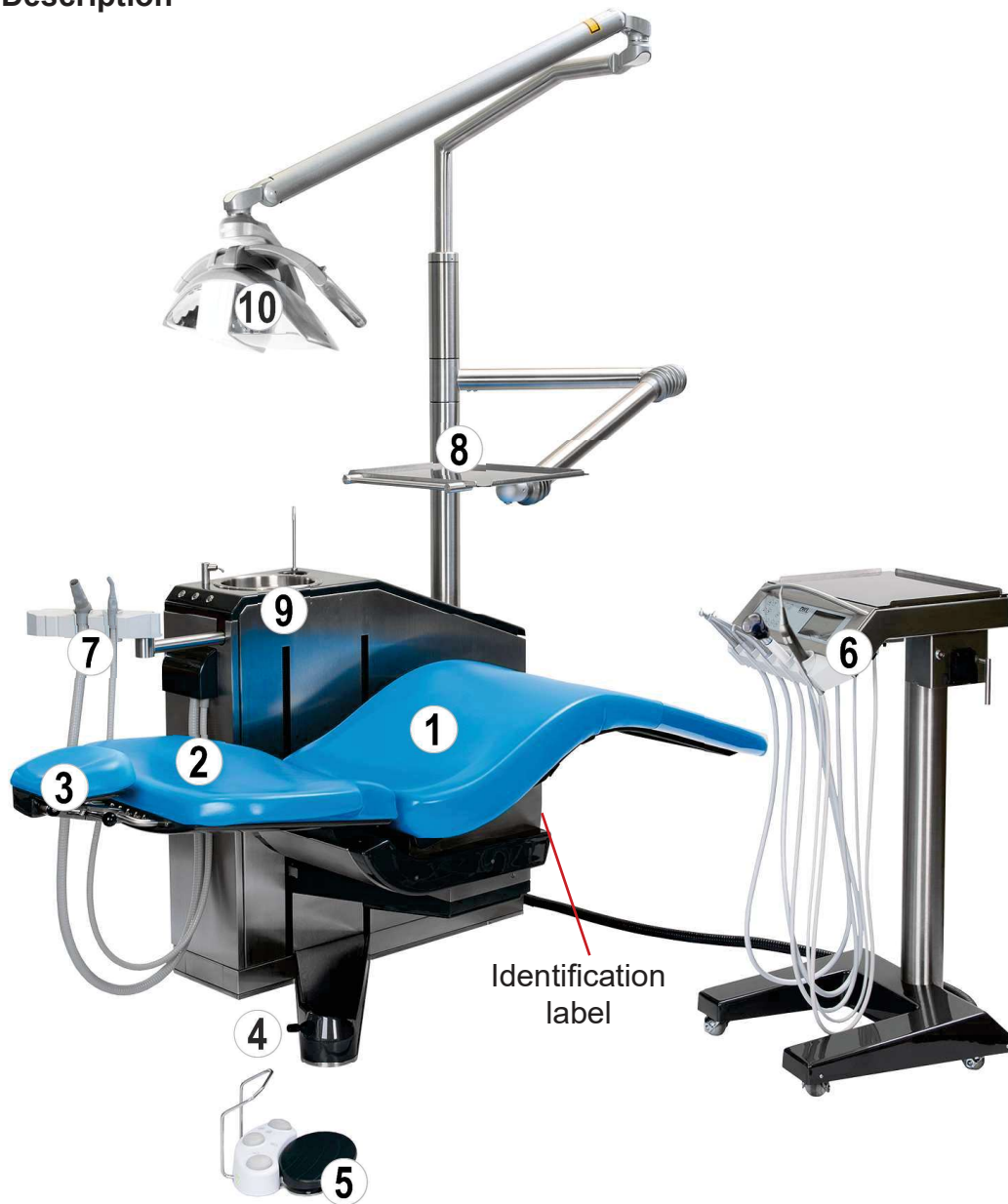

①	Treatment chair, seat
②	Treatment chair, back rest
③	Treatment chair, double-jointed headrest
④	Treatment chair, joystick
⑤	Foot controller doctor's device
⑥	Doctor's device
⑦	Assistant's device
⑧	Tray
⑨	Cuspidor
⑩	Operating Lamp LED.light EVA

Product Description



①	Tray for storage
②	Handle
③	Turbine connection
④	Micromotor
⑤	Micromotor
⑥	Piezo scaler
⑦	3-function syringe
⑧	Display
⑨	Pump
⑩	Implantmed motor
⑪	Stand
⑫	Spray mist suction
⑬	Saliva ejector



Connecting the instrument hoses:

The instrument hoses can be connected or disconnected via a plug connection under the doctor's device. Depending on the equipment of the model, the doctor's device is equipped with the following instruments (from the left): turbine connections, micro-motor(s), piezo scaler and the syringe. The instrument holders are marked on the back. Do not connect the tubes crosswise.



Assistant's device



Connecting the instrument hoses:

The instrument hoses can be connected or disconnected via a plug connection under the assistant's device. The assistant's device is equipped with the following instruments (from the left): 3-function syringe, spray mist suction and the saliva ejector. The instrument holders are marked on the back. Do not connect the tubes crosswise.

Product Description



Marking	Type of holder
GS	Spray mist suction
KS	Saliva ejector
T	Turbine connection
M	Micromotor
S	Syringe
P	Piezo Scaler

Foot Controller

The wireless S-NW foot controller enables hands-free operation of the instruments.



Only use high-quality disposable AA / Mignon / LR6 / 1.5 V batteries.

You will find further information on use, safety instructions, cleaning and battery replacement in the W&H instruction manual foot controller S-NW, S-N2.

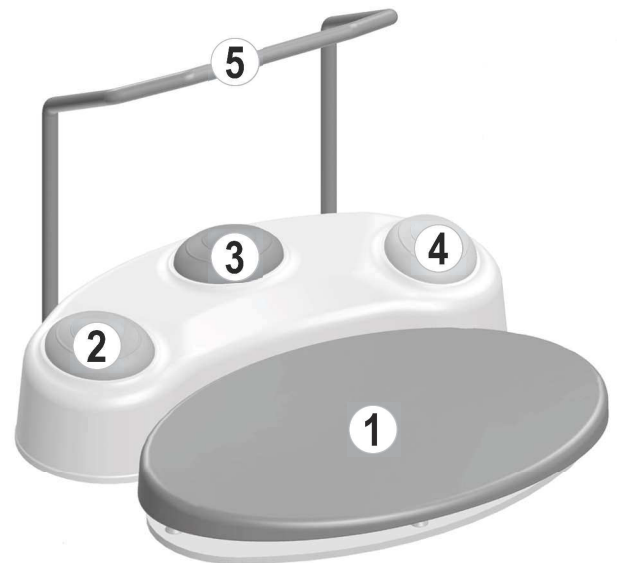

You can find an application film at www.youtube.com/watch?v=DKL_Germany.
Video: DKL CHAIRS L2-D2 SERIES WITH TOUCH SCREEN
FUNCTIONS FOOT CONTROLLER



LINK: <https://youtu.be/R803BCMsbvK>

①	Start signal for instruments
①	Stop / abortion of programme run
②	Press briefly: coolant
②	Press long: chipblower
③	Programmes to activate instruments
④	Press briefly: left/ right-hand rotation micromotor
④	Press long: dim operating lamp
⑤	Clamp for positioning

Icons – Display



Treatment chair, activate programme run

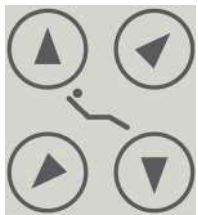

Lifting the treatment chair and moving the back rest



Display lock



Bell



Cup filler



Bowl rinser



You can find application films at [www.youtube](http://www.youtube.com) DKL Germany.
Playlist: DKL CHAIRS L2-D2 SERIES DOCTOR'S DEVICE WITH TOUCH SCREEN

LINK: https://www.youtube.com/playlist?list=PLBx4baZAs6WgjO9xNPs3m30bNHsd_DR4e

Icons – Navigation Touchscreen



Add user



Back



Confirm / save



Setup



To the next page



Edit



Decrease / Increase



Flush menu



Implantmed menu (if part of the configuration)

Icons – Information touch screen



Setting selected



Foot controller, wireless



Information



Error message, no further work is possible



Favourite selected



red = replace battery



Information with selection option



Error message, further work is possible

Icons – Setup



Touchscreen lock



Manage users



System



Setup foot controller



Setup touchscreen lock



Sound ON



Sound OFF (except warning sounds)



Device information



Language



Setup service

Moving the Treatment Chair

Joystick at the chair base

Move the joystick downwards

> Treatment chair moves downwards.

Move the joystick upwards

> Treatment chair moves upwards.

Move the joystick to the left

> Back rest tilts backwards.

Move the joystick to the right

> Back rest moves to an upright position.

Tap the Joystick Twice

> Treatment chair moves to the entry /exit position.

Tap the joystick twice downwards

> Treatment chair moves to the treatment position p2.

Tap the Joystick Twice to the Left

> Treatment chair moves to the rinsing position and back to the last position when tapping twice again.

Tap the Joystick Twice to the Right

> Treatment chair moves to the treatment position p1.



Programme keys at the back rest

Press “p0“

> Treatment chair moves to the position for getting on/off.

Press “p1“

> Treatment chair moves to treatment position p1.

Press “p2“

> Treatment chair moves to treatment position p2.

Press “p3“

> Treatment chair moves to treatment position p3.

Briefly press “lp“

> Treatment chair moves to the rinsing position and after renewed pressing back to the “last position”.



Saving programme keys p0 – p3

For programming the keys, move to the desired programme position manually and then keep the respective programme key pressed for about 3 seconds until you hear a signal tone. Now you have successfully saved your individual treatment position.

Saving programme key lp

Press the “lp” key to move the chair to the rinsing position. By pressing the key “lp” once again, the chair moves back to the previous programme position or to the manually set position. In order to programme the chair, move it manually to the desired rinsing position and then keep the key “lp” pressed for about 3 seconds until you hear a signal tone. Now you have successfully saved your rinsing position.



Emergency-Stop System

Briefly tap the joystick or any programme key at the back rest to stop the active programme immediately. For this purpose, you can also press the start button for the instruments at the foot controller.



Once an instrument has been activated, the treatment chair cannot be moved any more.



Programme Run

Press the programme keys “0” and “lp” simultaneously for about 3 seconds until you hear a signal tone. The treatment chair then moves the seat and the back rest into the lowest position. The motion sequence has been reset now.

Moving the Treatment Chair



When moving the back rest, there is a risk of injury or crush. The patient's hands and arms must always rest on the chair upholstery.

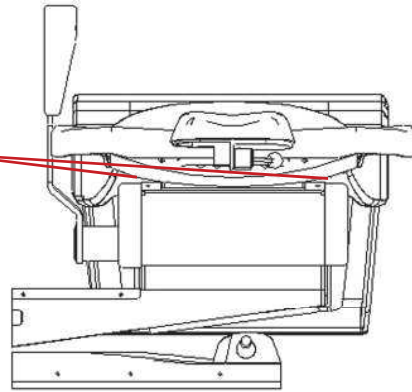

To facilitate getting on or off the chair, the right arm rest (optional) can be swivelled by 90°.



Pull the release lever up to freely adjust the double-jointed head rest. Press the lever down to fix the position of the double-jointed head rest. The release lever must always be pulled up completely to move the head rest.



Manually extractable double-jointed head rest.

You can find an application film at www.youtube.com/DKLGermany.
Video: DKL CHAIRS D2 SERIES FUNKTIONEN UPHOLSTERY POSITIONS



LINK: <https://youtu.be/o307-rWGp5A>

Putting the Treatment Unit into Operation



Only use your finger to operate the touchscreen. Operating the touchscreen with hard objects can scratch or damage the surface.



Putting the unit into operation

Before putting your treatment unit into initial operation, an intensive flushing must be carried out (→ page 55).

Activating / Deactivating the Treatment Unit



The treatment unit is equipped with a power switch ① on the chair base. The power switch connects the treatment unit with the power supply. In the event of longer downtimes, the treatment unit should be disconnected from the power supply. The treatment unit contains a device fuse ②. Switch on the treatment unit at the power switch. The power switch lights up green.

After the unit has been switched on, the operating system is booted.



Creating a User



Activate the setup



Add a user



Enter the user on the on-screen keyboard (max. 15 characters)



Store the user



The new user is displayed in the “Manage Users” menu

Activating a User



Select a user



Confirm the user



The active user is displayed under “My Favourites”.



Six user profiles can be created.

Changing the User



Activate “My Favourites”



Select a user



Confirm the user



The active user is displayed under “My Favourites”



You can find an application film at www.youtube.com/DKLGermany.
Video: DKL DENTAL D2-EP SERIES FUNCTION USER ADMINISTRATION

LINK: <https://youtu.be/xiJQcrJfxSU>

Managing Users



Activate setup



Manage users



Activate user



Copy user



Delete user



Rename user



Activate user

Main Menu Instruments

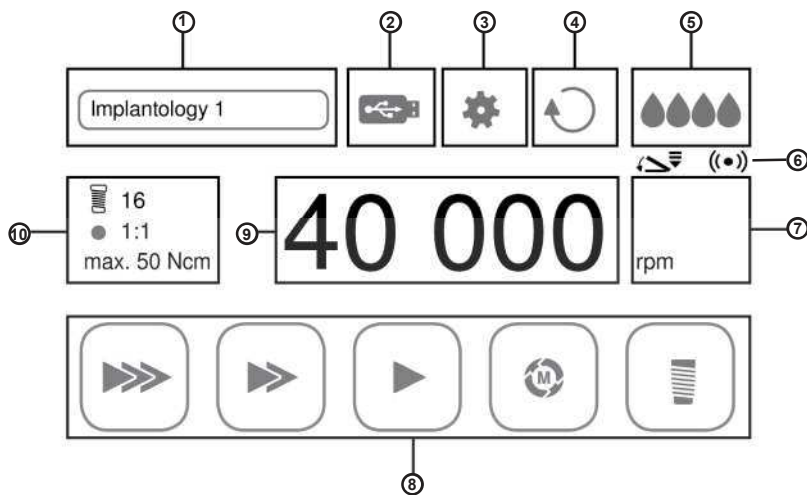

1	My favourites	6	Wireless foot controller (VARIABLE or ON/OFF)
2	Documentation (DOCU), if Implantmed	7	Display work mode
3	Setup	8	Display programme mode
4	Right/left-hand rotation	9	Speed (rpm) / torque (Ncm) / power (1-40)
5	Coolant: water (spray) or sterile solution (pump)	10	ProConfigure the programme

General Instrument Functions

Adjusting the Coolant



Spray on (water)

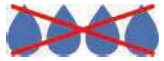

Spray off



Air only (adjustment not possible with the piezo scaler).



Selection via push-button ② on the foot controller.

Changing the Coolant Settings



Take out the instrument. Activate the coolant indicator ⑤ on the touchscreen.



Activate water



Activate pump for sterile solution (NaCl)



Decrease / increase pump flow rate



Pump 100%



Pump 75%



Pump 50%



Pump 25%



Pump off



Instruments can be operated without coolant. The dental substance can be damaged by frictional heat. Make sure that the treatment point is not overheated when you have switched off the coolant.

General Instrument Functions

Adjusting the Foot Controller



Take out the instrument. Activate the foot controller on the touchscreen (6).



Foot controller ON / OFF



Foot controller VARIABLE

Adjusting the Display Mode



Take out the instrument. Activate the work display mode (7) on the touchscreen.



Display speed / intensity of the instrument while activated in bar structure



Display speed / intensity of the instrument while activated in %



Display of total speed / intensity of the instrument while activated

Adjusting the Instrument LED



Remove the instrument



Setup settings



System



LED on



LED off



LED intensity during treatment



LED afterglow time



LED intensity during afterglow time

Starting the Turbine

- > Remove the turbine from the instrument holder.
- > Activate the start signal at the foot controller ①.
- > Put the turbine back into its holder.
- > The last coolant settings are saved.

Starting the Turbine (Advanced Air)



Air drive system for dental handpieces and dental air motors intended for general dental use. Removal of carious material, preparation of cavities and crowns, removal of fillings, finishing of tooth and restoration surfaces.

Full functionality is only possible with the W&H Primea Advanced Air Turbine. If another turbine or another instrument is plugged on, the Advanced Air works in standard turbine mode.



Plugging on the Roto Quick coupling and turbine (see also operating instructions of W&H Dentalwerk Bürmoos GmbH Primea Advanced Air).



- > Remove the Advanced Air turbine from the holder.
- > Activate programme configuration on the touchscreen ⑩ .

Power

In the „Power“ mode, the set speed is kept constant, even under increasing pressure on the rotating instrument, thus increasing the removal rate.

Tactile

The „Tactile“ mode allows a reduction of the removal rate under increasing pressure on the rotating instrument.



My Favourites - Program config



Activate programmes (up to 6 programmes possible)
> Activate program config.



back

Setting the speed



- > Activate the speed on the touchscreen ⑨.



Decrease / increase (setting range 60,000 to 320,000 rpm)



- > Activate the start signal at the foot controller ①.
- > Place the Advanced Air turbine in the instrument holder.
- > The last settings are saved

Starting the Electric Motor



See also operating instructions from W&H Dentalwerk Bürmoos GmbH Electric motor EM-12L.

> Remove the electric motor from the instrument holder.



Display work mode: restoration, prosthetics and prophylaxis



My Favourites - Program config

Preventive dentistry, conservative dentistry such as cavity preparation and prosthodontics such as crown preparation.
Speed setting range 1,000 - 40,000 rpm.

Activate programmes (up to 6 programmes possible)

> Activate Program config.



Activate programme P1. Continue this process for the desired number of programmes (P1 to P6)



back

Setting the transmission /configuring the programme



> Activate programme configuration on the touchscreen ⑩.



Transmission ratio



Activate / deactivate transmission

Setting the speed



> Activate the speed on the touchscreen ⑨.

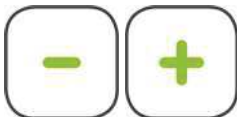

Decrease / increase



> Activate the start signal on the foot controller ①.

> Put the micromotor into the instrument holder.

> The last settings are saved.



You can find an application film at www.youtube.com DKL Germany.
Video: DKL CHAIRS L2-D2 SERIES FUNCTIONS DENTAL MICROMOTOR

LINK: <https://youtu.be/M3vhRr9rLMs>

Starting the Electric Motor



Motor left-hand rotation - The start signal is accompanied by a warning signal and the symbol is flashing. After the motor has been placed in the instrument holder, right-hand rotation is activated.



Motor right-hand rotation

Motor endodontic function



Root canal files are subject to wear and tear. Worn files can break off during treatment. Only use the files for the service life specified by the file manufacturer.



Incorrectly selected speeds and torque values endanger the patient. Treatment errors, e.g. the breaking of a file, can occur as a result of incorrect settings. Observe the manufacturer's specifications for the file systems.



The following file logs are already provided for the motor:

- > Sendoline S5
- > Sendoline NiTi-TEE
- > Komet F360
- > Komet F6 SkyTaper
- > VDW Mtwo
- > Dentsply Pro Taper

> Remove the electric motor from the instrument holder



Switching to Endo: In the main menu, under "My favourites", ① the active file log is activated and displayed.



Display work mode: endodontics



Changing the favourites ①

- > Tap on "My favourites" ①
- > Select file programme



Auto forward

When the motor reaches the set torque threshold, it stops and immediately turns briefly in the opposite direction. This process is repeated four times.



Auto reverse

When the motor reaches the set torque threshold, it stops and immediately turns briefly in the opposite direction. Then the motor stops.

Starting the Piezo Scaler



See also operating instructions from W&H Dentalwerk Bürmoos GmbH Piezo scaler handpiece.

> Remove piezo scaler from the instrument holder.



Display work mode: scaler



My Favourites - Program config

Drive unit with a piezoceramic oscillation system, which sets the scaler tip into linear oscillation. The drive unit is used for the removal of supragingival calculus and subgingival concretions as well as for endodontic applications and the preparation of hard tooth structure.

Power setting range: 1-40.

Activating programmes (up to 6 programmes possible)

> Activate Program config.



Activating Programme P1. Continue this process for the desired number of programmes (P1 to P6).



back

Setting the power



> Activate power on the touchscreen ⑨.

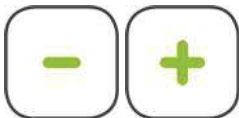

Decrease / increase



> Activate the start signal at the foot controller ①.

> Put the scaler back into its holder.

> The last settings are now saved.



> An overview of the correct power setting is provided for each type of tip.

> Only use tips approved by W&H and the corresponding tip changer or fork wrench.

> Check the wear of the tips with the enclosed tip card.

> Replace tips with visible material wear. The tips must not be bent and re-sharpened.

> Make sure that the original shape of the tip is not changed (e.g. by falling down).



You can find an application film at www.youtube.com/watch?v=DKL Germany.
Video: DKL CHAIRS L2-D2 SERIES FUNCTIONS PIEZO SCALER

LINK: <https://youtu.be/9ddlgJzl0Go>

Function Syringe Luzzani Minilight



See also operating instructions of the Luzzani company for their Minilight syringe!

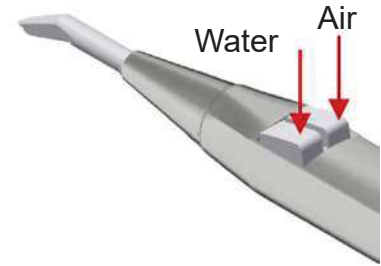
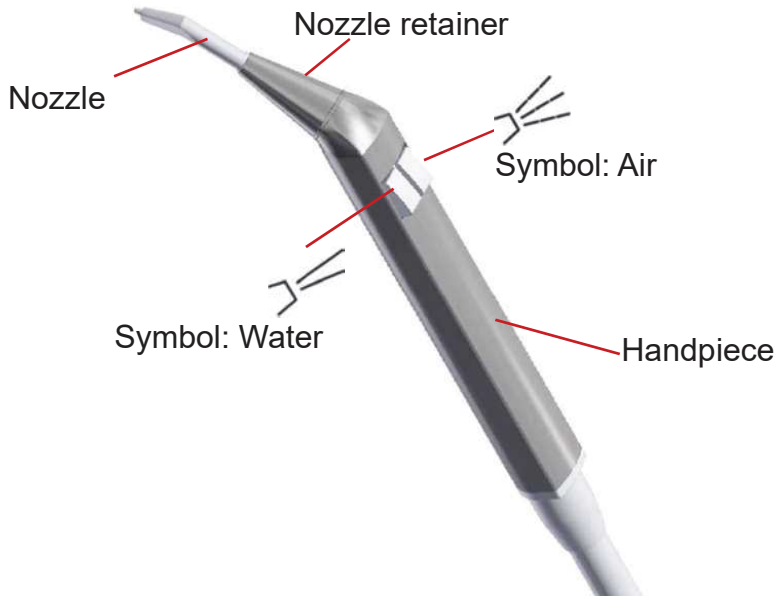

To blow water into the operating field, just press the left button on the handpiece, symbol: water.
 To insufflate air into the operating field, just press the right button on the handpiece, symbol: air.
 To blow a combination of air and water (spray), press both buttons on the handpiece at the same time.



After each use on a patient, the handpiece and tip of the syringe **MUST** be cleaned and sterilised to guarantee maximum hygiene.



Unscrew the nozzle retainer.



Withdraw the nozzle retainer.



Withdraw the nozzle.



You will find the sterilisation procedure

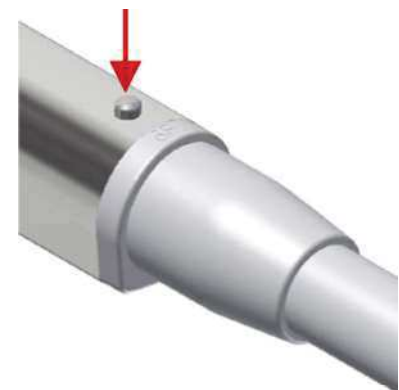

Press the pawl to release the handpiece.



Withdraw handpiece.



See also operating instructions for the W&H EM-19 LC electric motor Dentalwerk Bürmoos GmbH.

Electric motor with coolant supply for transmission instruments with ISO 3964 (DIN 13940) compatible coupling system for use in dental surgery, implantology, oral and maxillo-facial surgery (MFS).



Hygiene and care before first use

- > Sterilize the motor with cable and the universal holder.
- > Clean and disinfect the stand in the thermal disinfectant.



Rotational energy

As a result of the rotational energy saved in the drive system – compared to the value set – fast deceleration of the tool may cause the selected torque to be exceeded for a short time.



Observe the manufacturer's specifications regarding speed and torque when positioning superstructure screws. Please note that, as described above, positioning these screws mechanically presents a potential risk which needs to be assessed.



- > Always ensure proper operating conditions and suitable coolant.
- > Always ensure that you have a sufficient supply of suitable coolants and ensure adequate suction.
- > Only use suitable coolants and observe the manufacturers' medical specifications and instructions.
- > Use the W&H irrigation tubing set or accessories approved by W&H.

Irrigation Tubing Set



The scope of delivery includes sterile packaged disposable irrigation tubes. Order number 04363600 - Set with 6 tubes.



- > Observe the expiration date and use only disposable irrigation tubing with undamaged packaging.
- > Replace the disposable irrigation tubing immediately after each treatment.
- > Observe your local and national laws, guidelines, standards and regulations for disposal.

Icons Implantmed - Programmes



Programme 1 (P1)



Programme 2 (P2)



Programme 3 (P3)



Programme 4 (P4)
thread cutting function



Programme 5 (P5)
Implant placement

Icons Implantmed



Home button (back to the main menu)



Torque curve



Odontogram

1-32 UNS (Universal Numbering System = American odontogram)

I-IV FDI (Fédération Dentaire Internationale = International odontogram)



System check / test run



New position



New documentation



End documentation

Putting Implantmed W&H EM-19LC into Operation



Insert the stand.



Hook in the holder for the motor and fasten it.



Open the pump cover. Pull the handle upwards.



Insert the irrigation tube and close the pump cover. We recommend that you remove the pump cover before inserting the irrigation tube.



Plug in the motor cable.



Place the motor in its holder.



Connecting the motor cable

1. Pay attention to the positioning (1+2).
2. Check that it is held securely in place.



Do not attach or remove during operation.

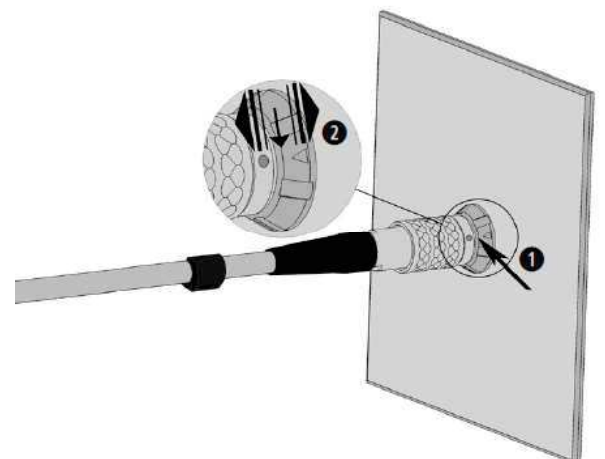

Implantmed Settings



Open the Implantmed menu

My Favourites

> Select a drill log

Selecting a drill log group

> Generate / select / change the drill log

> Setting the drill log: Edit, copy, rename, activate, delete, favourite



An activated drill log cannot be deleted.

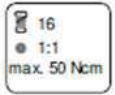

Setting the Programme

> Transmission

> Speed



At a speed of 40,000 rpm, the accuracy of the set speed is $\pm 10\%$.

> Torque (P4, P5)



Setting range 5 - 80 Ncm only for WI-75 and WS-75

The motor switches off automatically when the set torque is reached in left- or right-hand rotation. The accuracy of the set torque with the W&H WI-75 and WS-75 contra-angle handpieces is $\pm 10\%$ at a torque of 20 - 50 Ncm. Larger deviations are possible with different contra-angle handpieces.

> Documentation (DOCU)



DOCU does not appear until documentation has been started.

Work Display Mode

> Bar

> Percentage

> Absolute

> Factory Default > My Favourite > Implantology1

Implantology1	P1	P2	P3	P5 right	P5 left
Transmission	1:1	WS-75 (20:1)	WS-75 (20:1)	WS-75 (20:1)	WS-75 (20:1)
Speed rpm	35.000	1.200	800	15	15
Setting range rpm	200 – 40.000	10 – 2.000	10 – 2.000	10 – 50	10 – 50
Motor rotation direction	right	right	right	right	left
Pump	on	on	on	off	off
Torque Ncm	100 %	100 %	100 %	20	50
Setting range Ncm	-	-	-	5 – 80	5 – 80

Settings Implantmed

> Factory settings > My Favourite > Impantology2

Implantology2	P1	P2	P3	P4 right	P4 left	P5 right	P5 lleft
Transmission	1:1	WS-75 (20:1)	WS-75 (20:1)	WS-75 (20:1)	WS-75 (20:1)	WS-75 (20:1)	WS-75 (20:1)
Speed rpm	35.000	1.200	800	20	20	15	15
Setting range rpm	200 – 40.000	10 – 2.000	10 – 2.000	10 – 50	10 – 50	10 – 50	10 – 50
Motor rotation direction	right	right	right	right	left	right	left
Pump	on	on	on	on	on	off	off
Torque Ncm	100 %	100 %	100 %	20	60	20	50
Setting range Ncm	-	-	-	5 – 80	5 – 80	5 – 80	5 – 80

> Factory settings > My Favourite > Oral Surgery

Oral surgery	P1	P2	P3
Transmission	1:1	1:1	1:2,7
Speed rpm	35.000	10.000	108.000
Setting range rpm	200 – 40.000	200 – 40.000	540-108.000
Motor rotation direction	right	right	right
Pump	on	on	on
Torque Ncm	100 %	100 %	100 %

Thread cutting function (chip breaker mode)



When the foot controller is activated, the thread cutter is turned up to the set torque. When the set torque is reached, the device automatically switches to left-hand rotation. When the pedal is released and then activated again, the device changes back to right-hand rotation.



If the thread cutting function is in left-hand rotation, the control device can also start with the maximum torque.

Documentation (DOCU) Implantmed



The documentation of drill logs, torque curves and ISQ values is only possible in programmes 4 or 5.

The documentation must be activated or deactivated for each programme.

A USB-stick must be plugged in to save the documentation.

Never remove the USB-stick while the motor is running.



Recording the Documentation

> Plug in the USB stick



Icon appears

> Enter ID

> Enter date

> Select tooth quadrant

> Select tooth

> Confirm selection



The documentation starts with the start of the motor.

Further documentation



> Add new position

> Start new documentation

> Exit documentation



After the motor has stopped, a diagram appears, which is automatically saved on the USB-stick.

Processing the documentation

A text file (csv) and a PDF file are saved on the USB stick.

The text file can be opened for further processing in Microsoft® Excel*.

The PDF can be opened in the Adobe® Reader®**.

* Microsoft® Excel® is a registered trademark of the Microsoft® Corporation in the United States of America and/or other countries.

** Adobe® Reader® is a registered trademark of Adobe Systems Incorporated in the United States of America and/or other countries.



The USB-output is located below the doctor's device.

Operating Lamp LED.light EVA

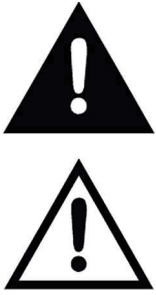

For the intended use, please observe the operating instructions issued by FARO: USER MANUAL EVA

When swivelling and moving the operating lamp, always make sure that no objects or persons are in the swivelling range of the arm system. Otherwise, personal injury or property damage may occur.

In order to move the operating lamp only touch its handles!

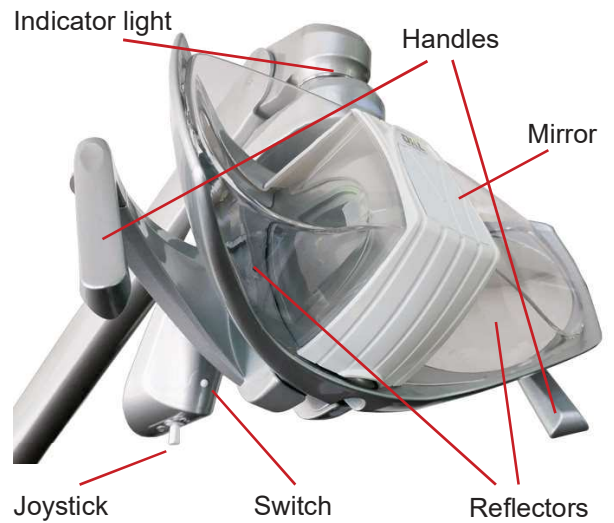

Switching on/off on the joystick:
Push right or left



Decrease the light intensity on the joystick:
Push right and keep pushed until desired intensity is reached.

Increase the light intensity on the joystick:
Push left and keep pushed until desired intensity is reached.



light intensity indicator

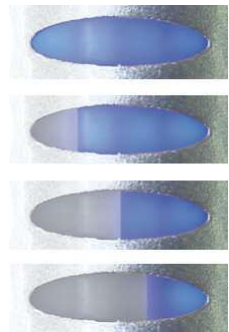

change in light intensity

Dimming the light intensity via the foot control:

In addition, the operating lamp can be dimmed via the foot controller. By keeping the button ④ on the foot controller pressed, you can select the desired intensity of the operating lamp.



Operating Lamp LED.light EVA

Changing the color temperature via the switch:

Every time a double click is performed, the colour temperature in Kelvin (Tk) of the light changes. Repeat the procedure until the desired colour temperature is shown on the indicator light. 2 beeps will inform the user that Tk is changing.



Indicator light
yellow
4000 Kelvin



Indicator light
white
5000 Kelvin



Indicator light
blue
5700 Kelvin



Composave setting



Composave setting on the joystick:
Push forwards or backwards.



Composave setting on the switch:
Single Click.



Acoustic signal and
indicator light
switches to orange.

Mirror

Loosen the plastic cover at the front of the protective cap by lightly pressing on its upper end.

On the back of the cover there is a mirror. Attach the mirror to the plastic cover.



You can find an application film at www.youtube.com/DKLGermany.
Video: DKL CHAIRS L2-D2 SERIES FUNCTIONS LED.LIGHT OPERATING LAMP EVA

LINK: <https://youtu.be/vaKW9RdjtLM>

Cleaning and disinfection of the Operating Lamp LED.light EVA

Pull the protective cap towards you to remove it for cleaning.



Cleaning and care

The reflectors must be cleaned with cotton wool and ethyl alcohol. Do not use detergents that contain surfactants or water-repellent substances (staining).



Cleaning, disinfection and Sterilisation of the handles

To remove the handles, turn the handle lock on the handles and pull off the handles. To mount the handles, reattach them and push them to the limit. Then lock the handle lock.



Cleaning and Disinfection of the handles

Before sterilising the handles, they must be decontaminated and disinfected.



The handles cannot be disinfected by thermo-disinfection.



Sterilisation of the handles:

The handles must be packaged in compliance with EN 868-5. The handles can be sterilised with standard cycles 121°/134° C up to two hundred (200) cycles or however up to loss of the mechanical performance.



Cycle EN 13060	Temperature	Pressure	Holding time minimum
B	121°C	207 kPa	15 min.
B	134°C	308 kPa	3 min.



Warning against danger of wear and corrosion and falling suspended mass.

For all metal or plastic parts it is strictly forbidden to use substances that are abrasive, corrosive, acids, substances containing chlorine or chloride ions, phosphorous or phosphorous ions or detergents with Trilene base, petrol, white spirit, chlorine or similar.

Do not use detergents-disinfectants containing the following substances to clean plastic parts:

Ammonium Hydroxide, Sodium Hydroxide, Hydrogen peroxide, Ammonium Chloride, Methylene Chloride, Methyl Alcohol, acids and corrosive substances of all kinds.

It is forbidden to directly spray any chemical substance on the device.

Tray

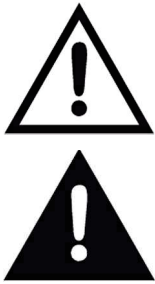

The tray should be set correctly for your standard equipment and thus remain in its desired position. The maximum load of the tray is 2 kg. Do not lean on the tray.

Pull back the bellows until the adjusting screw (1) is visible. Place your standard equipment on the tray (max. 2 kg) and move the tray into a horizontal position.

Set the adjusting screw (1) so that the arm remains in the horizontal position (with a slight upward tendency).

Turn the adjusting screw in the „ + „ direction = high weight.

Turn the adjusting screw in the „ - „ direction = low weight

Secure the 3 grub screws (2) with safety lacquer (blue).

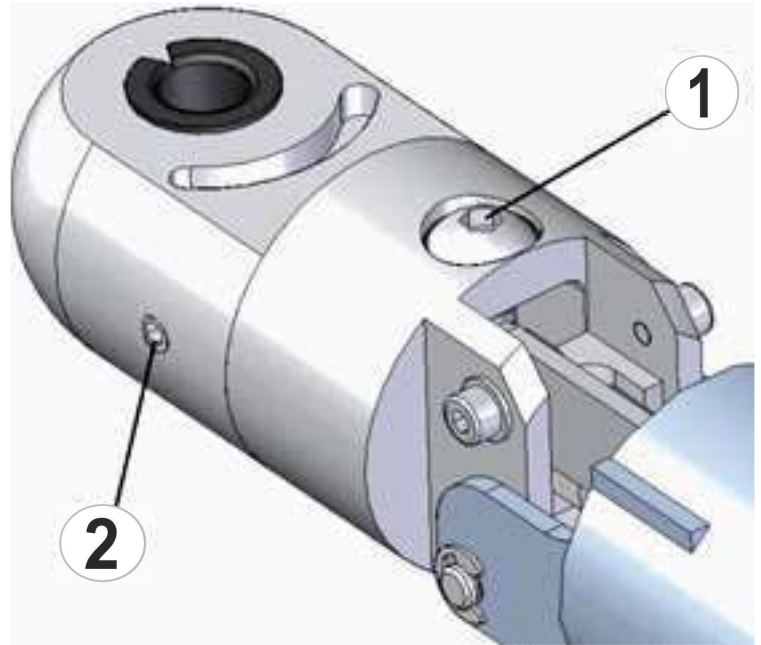

With the adjusting screw, the tray can be aligned in its radially horizontal position.

Pull back the bellows until the adjusting screw (1) is visible.

Move the tray into a horizontal position.

Secure the adjusting screw (1) for the inclination with thread locking fluid (blue).

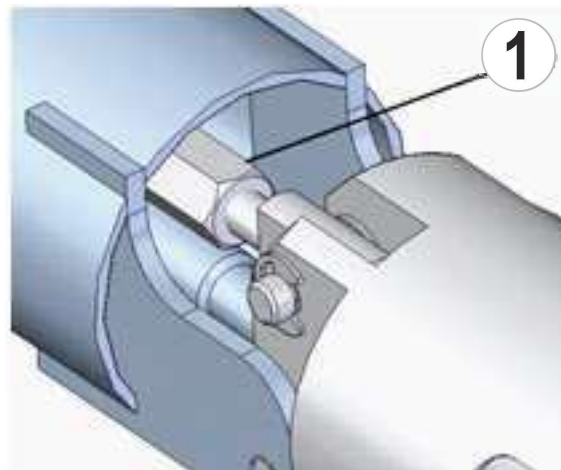

You can find an application film at [www.youtube DKL Germany](https://www.youtube.com/watch?v=DKL_CHAIRS_L2-D2-RANGE_TRAY_SETTINGS).
Video: DKL CHAIRS L2-D2-RANGE TRAY SETTINGS

LINK: <https://youtu.be/r-Y14eEYtqI>

Cuspidor



①	Operating status with installed water separation unit
②	Bowl rinser
③	Glass filler



The factory setting for the bowl rinser is 7 seconds.
The glass filler is factory-set to 3 seconds.



Activate the bowl rinser at the display of the doctor's device or at the cuspidor.



Activate the cup filler at the display of the doctor's device or at the cuspidor.

Changing the bowl rinsing time.



Keep the bowl rinser key at the display of the doctor's device or at the cuspidor pressed.
After 2 seconds, a short signal is audible. Keep the key pressed until the desired rinsing time has been reached. Successful storage is confirmed with another signal tone.
Maximum rinsing time: 25 seconds.

Changing the Filling Time for the Cup



Keep the cup filler key at the display of the doctor's device or at the cuspidor pressed.
After 2 seconds, a short signal is audible. Keep the key pressed until the desired fill level has been reached in the glass. Successful storage is confirmed with another signal tone.
Maximum filling time: 10 seconds.



After switching on the treatment unit, the bowl rinsing process starts automatically for the saved duration and rinses the bowl.



You can find an application film at www.youtube.com/DKL_Germany.

Video: DKL CHAIRS L2-D2 SERIES FUNCTIONS CUSPIDOR CUP FILLER & BOWL RINSER

LINK: https://youtu.be/SsFSKdpJI_I

Cleaning the Sieve

Clean the sieve in the cuspidor bowl once a day under running water.



To reduce the risk of infection, liquid-tight gloves must be worn during maintenance work.



Never work without a filter, otherwise there is a risk that parts will settle in the suction system and thus impair its function.



Suction



Reflux Effect

When the suction cannula adheres to the mucous membrane of the oral cavity or to the tongue, a so-called reflux effect may occur. To prevent cross-infection among patients we recommend using suction cannulas with air-bleed openings. Here a defined bypass airstream is introduced into the suction handpiece via lateral recesses. Even if the cannula adheres to the mucous membrane of the oral cavity or to the tongue and is thus blocked, a sufficient airstream from the patient to the suction system (and not the other way round!) is maintained.

Remove the suction tube from the suction tube retainer. By opening the slider or turning the control knob, the suction power is active.

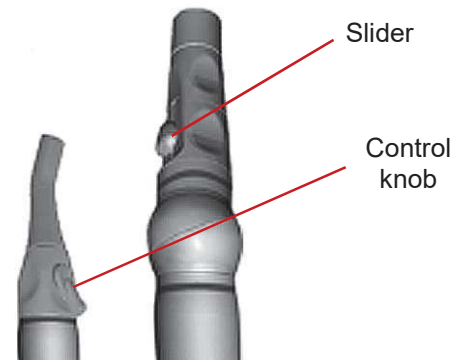

Cleaning the suction filter



To reduce the risk of infection, liquid-tight gloves must be worn during maintenance work.



Open the lid of the filter drawer on the assistant's device to clean the disposable filter (daily) and replace it if damaged. The filter is designed as a disposable filter and cannot be thermally disinfected.



Never work without a filter; otherwise there is a risk of parts settling in the tube holder and impairing its function.

Suction System



For the intended use, please observe the operating instructions issued by DÜRR Dental:

- > Cuspidor valve, Version 3
- > CAS 1 operating instructions issued by DÜRR Dental
- > CS 1 operating instructions issued by DÜRR Dental, depending on the equipment and design of the suction system.

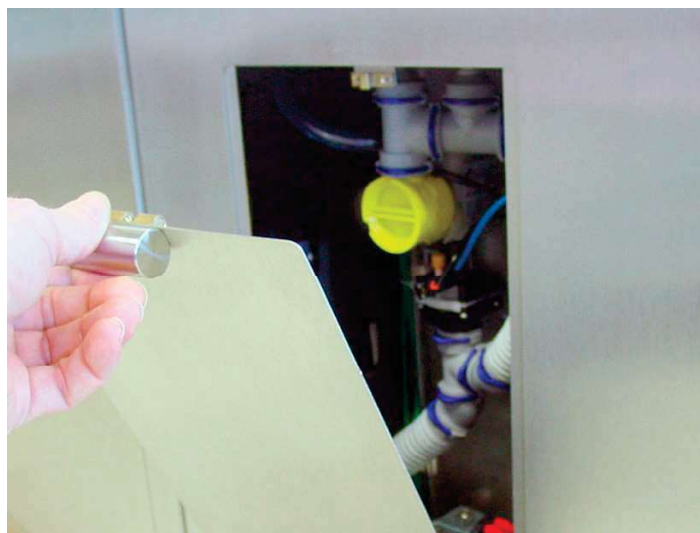

Open the door of the cuspidor fountain by pulling the handle. Depending on the equipment and design of the suction system, you will find the following in the cuspidor:

- > Cuspidor valve, Version 3 (wet suction)
- > CAS 1 operating instructions issued by DÜRR Dental (dry suction)
- > CS 1 operating instructions issued by DÜRR Dental (dry suction)

Cleaning and Disinfection of the Suction Handpieces

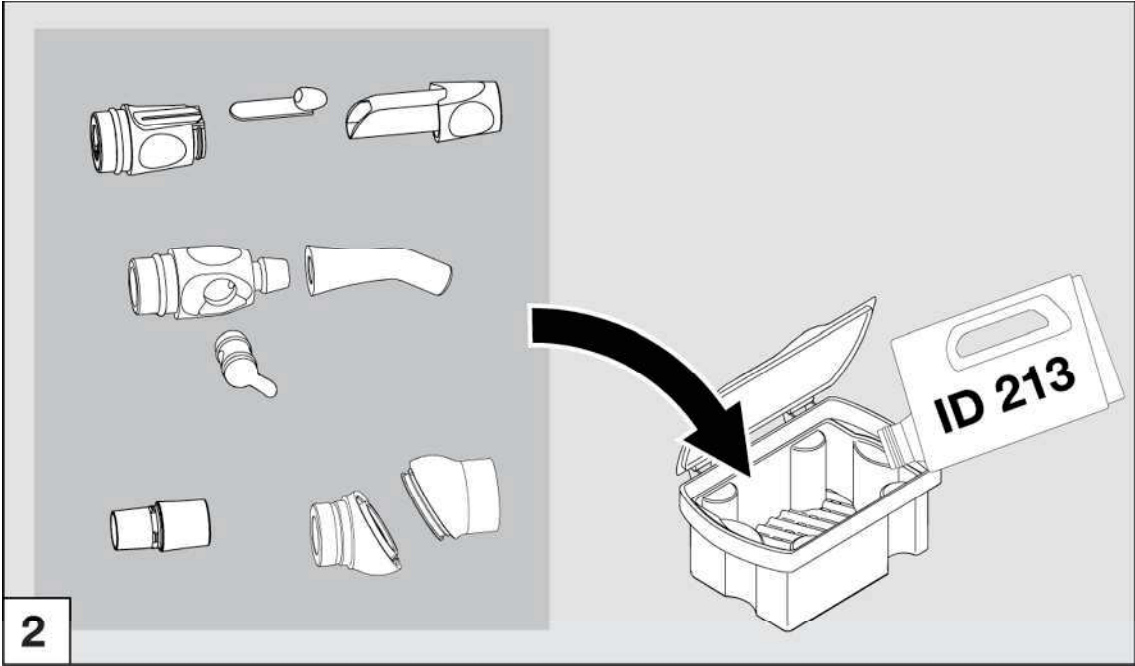
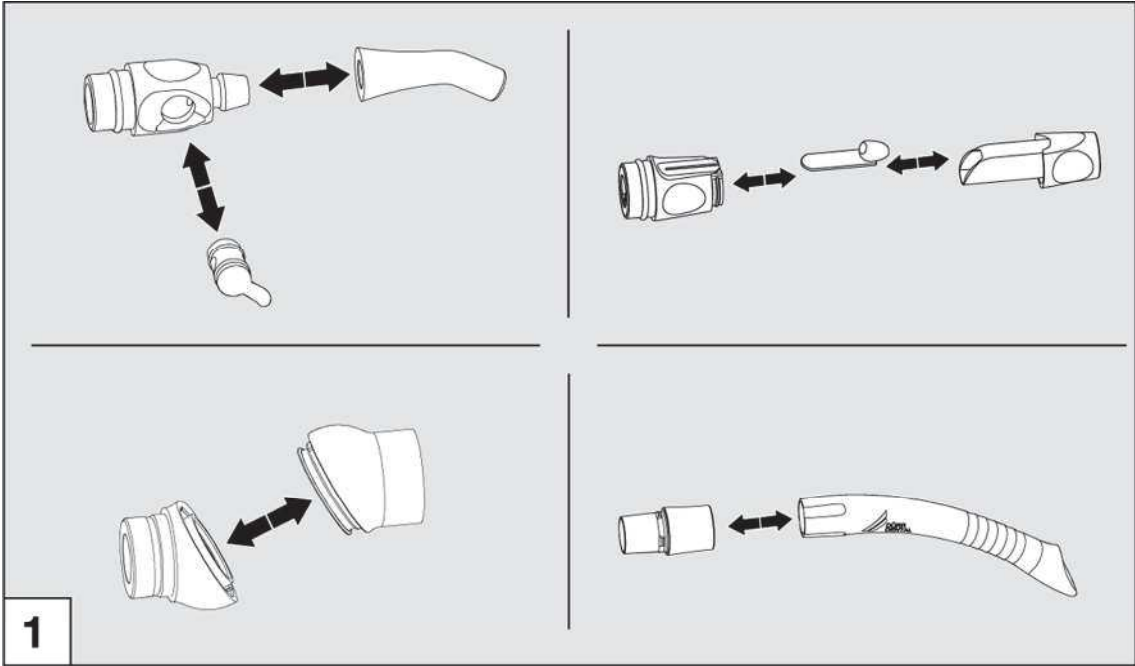

Cleaning and Disinfection of the Suction Handpieces

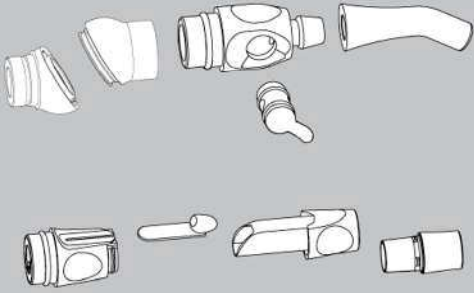
	Temperatur / Temperature	134 °C	
	Überdruck zur Umgebung / Overpressure to environments	2,16 bar 0,216 MPa	
	Haltezeit / Working time	5 min	

 Für weitere Informationen zur manuellen und automatischen Aufbereitung siehe Montage- und Gebrauchsanweisung Schlauchablage Comfort, Best.-Nr.: 9000-606-18. Siehe auch Download-Bereich unter www.duerr.de.

For further information for manual and automatically preparation of materials refer to the hose manifold Comfort Installation and Operating Instructions, order no.: 9000-606-18. See also download pages at www.duerr.de

3

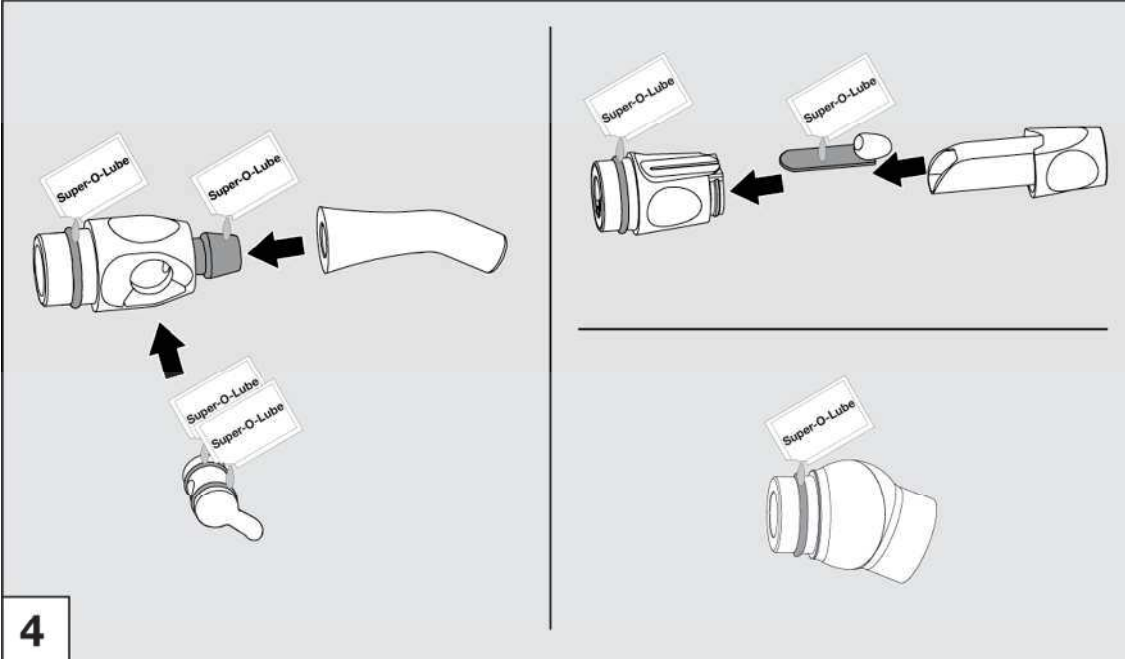

4

Cleaning and Disinfection of the Suction System

We recommend using the OroCup system of the DÜRR company for cleaning and disinfection.



Scope of delivery

1. OroCup, order no. 0780-350-00
2. 2 x Ø 16 mm insert (for large suction tube), (1x loose, 1x fixed)
3. 2 x Ø 6 mm insert (for the saliva ejector),
4. 1 x Ø 11 mm insert (other)



Drotol® plus MD 555 cleaner

Consumables

- Orotol® plus suction unit disinfectant CDS110P6150 liquid concentrate
- MD 555 cleaner, special cleaner for suction units CCS555C6150 foam-free concentrate for dental suction units and discharge lines

Product Description

The OroCup care system is a closed dosing system for easy preparation and aspiration of disinfectants and special cleaning agents for suction system. With the OroCup, the suction systems can be equipped with all the components and the cuspidor can be cleaned and disinfected. The OroCup is suitable for standard suction tubes with different diameters. In the lid of the OroCup, there is one fixed insert for Ø 16 mm tubes. Two further inserts can be selected and used, depending on the diameter of the suction tubes. As needed, 1 - 3 suction tubes can be attached at the same time; unused connections have no influence on the function.

1. Selecting and Attaching Inserts

- Select and attach the insert according to the diameter of the suction tube (Ø 16 mm for the large suction tube, Ø 6 mm for the saliva ejector). Unused connections have no influence on the function.

2. Cleaning and Disinfecting the Suction System

- Cleaning and disinfecting take place at the end of the treatment day; at higher utilisation levelstwicetwice per day (e.g. at noon and in the evening or as needed).
- Wear personal protective equipment.

2.1 Pre-Cleaning with Water

- Aspirate 2 litres of water.

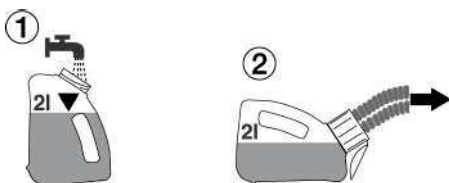

Cleaning and Disinfection of the Suction System

2.2 Preparation in the OroCup

- Depending on how much you need, prepare 1 or 2 litres of ready-to-use solution. Observe the manufacturer's instructions.



- Close the lid of the OroCup and shake the OroCup.

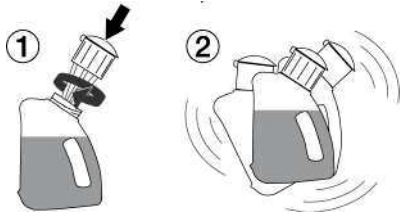

2.3 Positioning the OroCup and Aspirating

- Open the lid of the OroCup.
- Attach the disinfected suction handpieces and aspirate the ready-to-use solution for use.

Up to 2 litres of ready-to-use solution can be prepared in the OroCup.

Position the OroCup for aspirating the ready-to-use solution as follows:

- When aspirating the liquid, place the OroCup in a vertical position.

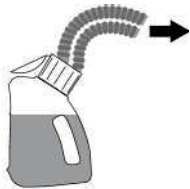

2.4 Cleaning and Disinfecting the Cuspidor Bowl

- Use at least 250 ml of ready-to-use solution per cuspidor bowl.

2.5 Final Rinsing

- After the exposure time has elapsed, aspirate 2 litres of water, see 2.1 (Pre-cleaning with water).



You can find an application film at www.youtube.com/DKL_Germany.

Video: DKL CHAIRS L2-D2 SERIES CLEANING AND DISINFECTION OF THE SUCTION SYSTEM

LINK: <https://youtu.be/39Lo60yeZnw>

Cleaning and Disinfection of the Surfaces

Hygiene and Care of the Stainless-Steel Surfaces

The regular cleaning of stainless-steel surfaces is recommended for hygienic as well as aesthetic reasons and serves to remove grease stains or finger marks. These can be easily removed with commercially available chlorine- and acid-free stainless-steel cleaners. We recommend applying Prestan to the surface in question.

Most stainless-steel care products contain silicone oil. Using these products can make your work a lot easier. They effortlessly remove any finger marks, but do not necessarily prevent new ones. Depending on the intensity of use, the protective layer remains in place for a few days. Microfibre cloths slightly moistened with water have also proved to be very effective.

Never use abrasive agents such as scouring powder, scouring milk or steel wool as these may cause scratches. Brushed surfaces must always be wiped in the direction of the finish. For this purpose, we recommend using a microfibre cloth. After cleaning, we recommend always wiping stainless-steel surfaces dry with a lint-free cloth to remove water stains or residual cleaning agent.

Disinfection of Stainless-Steel Surfaces

Do you put emphasis on a germ-free surface? Here, too, stainless steel proves to be extremely robust. Any commercially available chlorine-free disinfectant can be used.

Tests have shown that stainless steel is considerably easier to disinfect than other materials and even a lot less disinfectant is required in order to meet hygiene requirements.

The Most Important Facts at a Glance:

Effective and generally safe to use on surfaces are

- Soft sponges or microfibre cloths,
- Soapy water (to remove greasy stains),
- Diluted vinegar (to remove lime),
- Sodium bicarbonate (to remove coffee stains),
- Soda (to remove tea stains),
- Alcoholic solvents (to remove glue) and
- Special stainless-steel care products (for cleaning and conservation).



Caution is called for with

- Disinfectants containing chlorine and cleaning agents containing bleach (risk of corrosion).



Never use:

- Scrubbing sponges (scratches and extraneous rust),
- Scouring powder (scratches)
- Silver polish (corrosive).



The glass display of the doctor's device can be wiped clean. DKL recommends using wipe disinfection. Only use disinfectants that do not have a protein fixing effect.

Cleaning and Disinfection of the Surfaces

DentaClean: cleaning agent for imitation leather and plastic surfaces



Properties

DentaClean gently and easily cleans soiled imitation leather and plastic surfaces.

Use

Test on a hidden area first. We recommend cleaning the chair upholstery at the end of every treatment day. This is particularly important with light colours; any visible soiling must be removed immediately. Use the provided sponge to apply DentaClean in circular motions to the surfaces to be cleaned. Then remove moisture and dirt with a soft, absorbent cloth. For a thorough cleaning, use a cleaning brush instead of the sponge twice a week. Finally, seal with DentaProtect. Upholstery that is treated regularly and properly with DentaProtect is easier to clean!

DentaProtect: Care and protection for your imitation leather upholstery



Properties

DentaProtect is a product for caring and protecting heavy-duty imitation leather upholstery. Sealing the surface, it acts as a micro-binding agent and protects the upholstery from damage due to abrasion, soiling and also discolouration by non-fixed colourants in clothes.

Application

After the thorough end of the day cleaning cycle, apply the DentaProtect sealing evenly to the dry upholstery. You need 1 – 2 wipes for the complete upholstery set of your treatment chair. Close the box immediately after taking out the wipes.

Disinfection of medical artificial leather



Products: Wipe disinfection for plastics.

What: Upholstery, Covers (trays, panels etc.).

When: After every patient.

Cleaning and Disinfection of the Surfaces

DKL
REINIGUNG & PFLEGE

DKL GmbH
An der Ziegelei 4 • 37124 Rosdorf • Germany
Tel. +49 (0)551-50 06 0 • info@dkl.de
Shop: www.dkl.de



Cleaning and Care

Care set

1 x DentaClean 200 ml spray foam cleaner (article DC200)
1 x DentaProtect wipe dispenser box (article DP100)
1 x cleaning brush, 3 x cleaning sponges

Article number PSET

DentaClean 1000ml
Refill bottle for spray foam cleaner

Article number DC1000

DentaClean 200ml
Spray foam cleaner incl. 2 x cleaning sponges

Article number DC200

DentaProtect wipe dispenser box
100 wipes in a disposable sealing bag

Article number DP100

DentaProtect wipe dispenser set
6 wipe dispenser boxes with 100 wipes each in a disposable sealing bag

Article number DP600

Cleaning brush set, 4 pieces

Article number RB4

Cleaning sponge set, 8 pieces

Article number RS8



You can find an application film at www.youtube.com/DKLGermany.
Video: MEDICAL UPHOLSTERY – CLEANING DISINFECTION PROTECTION

LINK: <https://youtu.be/kM2E0kM6J1M>

Cleaning and Disinfection of the Instrument Holders

- Pull out the instrument holder
- Rinse off any soiling with water
- Remove any residual liquid (absorbent cloth; blow dry with compressed air)
- Disinfection with disinfectants; wipe disinfection is recommended.
- Observe the disinfectant manufacturer's instructions for use
- After manual cleaning and disinfection, a steam sterilization (packaged) in a steam sterilizer class B or S (in accordance with EN 13000) is necessary.
- Remove any soiling on the instrument panel with a damp cloth.
- Remove any residual liquid (absorbent cloth; blow dry with compressed air)
- Disinfection of the instrument panel with disinfectants; wipe disinfection is recommended.
- Observe the disinfectant manufacturer's instructions for use
- Put the instrument holders back into their respective positions.



Marking	Type of holder
GS	Spray mist suction
KS	Saliva ejector
T	Turbine connection
M	Micromotor
P	Piezo scaler
S	Function syringe



The supply tubes are not approved for mechanical cleaning (thermo washer disinfectant) and sterilization. Do not twist or fold the supply tubes! Do not roll up the tubes too tightly!

Check for Oil Residues in the Turbine Return Air

Proper maintenance of the turbine handpieces will not allow oil residue to accumulate in the turbine connector. During manual maintenance, there may be excess oil in the turbine handpiece. Therefore, check the turbine connection regularly for oil residues. You will find the connection at the end of the hose below the doctor's device. If oil residue has accumulated, proceed as follows:

1. Twist off the turbine connection anti-clockwise at the end of the hose.
2. Remove the oil residues and dispose of them properly.
3. An absorbent filter wadding can be inserted into the connecting spout as a precaution.
4. Screw the turbine connection back on.

In case of recurring oil residues, check and adjust the maintenance procedure for the turbine handpieces. Automatic maintenance devices do not leave oil residue and are therefore recommended.



Water Separation Unit (WSU)

The water separation unit meets the requirements of ISO 7494-2 and EN 1717 (free outlet with separation distance ≥ 20 mm). It is intrinsically safe in accordance with DVGW (German Technical and Scientific Association for Gas and Water) worksheet 540 and also meets the requirements of W270 and KTW (guideline for hygienic assessment of organic materials in contact with drinking water). It can be directly connected to the public drinking water supply. The water separation unit is a downstream dosing unit for the maintenance of the quality of the supplied water.



The LED button for the WSU is on the cuspidor. The WSU is started automatically by the control system of the dental unit. A manual start of the WSU is only necessary when the corresponding push-button signal is received.

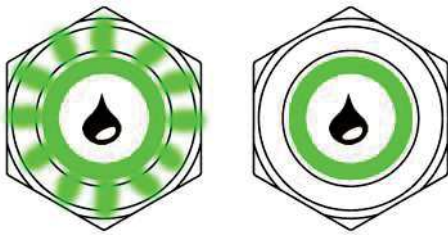

The push-button on the WSU flashes green = start process with start filling. The push-button of the WSU is constantly green = normal operation. After switching on the dental unit, the water separation unit goes into normal operation after approximately 50 seconds; water release is enabled.

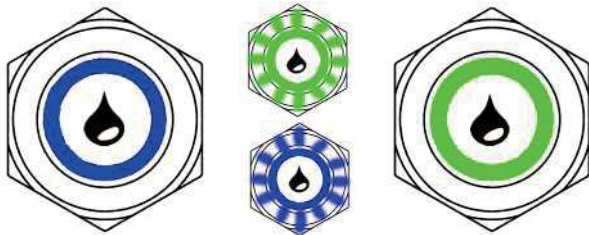

Intensive flushing is activated by a double click on the push-button. The WSU button lights up permanently blue during the phase of double dosage. When the rinsing is activated, the WSU button flashes green-blue. When the rinsing process is finished, the button lights up permanently green. The return to normal operation is indicated on the display.



When the push-button of the WSU flashes yellow, DK-DOX 150 must be refilled. You can continue to work without restriction and interruption until the treatment unit is restarted.

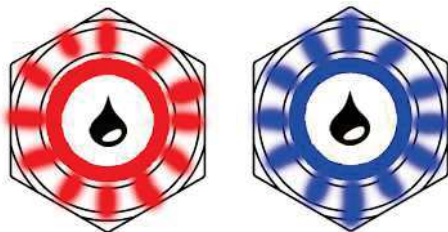

The push-button of the WSU flashes red-blue after a restart of the treatment unit. DK-DOX 150 must be refilled! Caution! Continued operation without DK-DOX 150 only possible after confirmation by briefly pressing the button. If DK-DOX 150 is not refilled, the button of the WSU indicates this by flashing yellow after the start phase.

Error Messages and Service Mode



WARNING!

Push-button of the water separation unit (WSU) is flashing yellow-red. Fault in the dosing unit. WSU continues to work. Call customer service!



Push-button of the WSU is flashing red. Call customer service immediately!



Push-button of the WSU lights up permanently red. Immediately call customer service! Switch off the treatment unit at the main switch! The overflow sensor has tripped! There is a malfunction of the level sensor and / or the travelling valve.



Push-button of the WSU lights up permanently magenta. Immediately call customer service! Switch off the treatment unit at the main switch!



Push-button of the WSU flashes magenta. The WSU stops! The filling process of the supplied water is too slow. Reset the WSU by keeping the button pressed for 8 seconds and restart it by pressing the button briefly. If the magenta flashes continue, call customer service!



SERVICE MODE!

Keep the push-button of the WSU pressed for 8 seconds. The push-button of the WSU lights up white. The mixing tank, the double-piston pump and, if necessary, all the tubing of the dental unit are pumped empty. For this purpose, the instruments and the glass filler must be activated to get the water out of the water lines. Completion of the emptying process is indicated by a white double flashing. After that, the WSU is in standby mode. The LED-ring of the push-button is switched off.



Flushing Function with the Water Separation Unit (WSU)



If the treatment unit is equipped with a water separation unit, make sure that the LED button on the cuspidor lights up green.



Open the menu "Flushing" at the touchscreen



Select NORMAL (Daily before the first treatment).



Select QUICK (20 sec, recommended after each treatment).



Message: Take out all the instruments

Hygiene Cover

The convenient hygiene cover helps to rinse all instruments easier.



Put the hygiene cover into the cuspidor bowl. Remove all the instruments from their holders and insert them into the hygiene cover. Start with the turbine connections, micromotors and the piezo scaler tube. Then clamp the syringes into their fixtures. Only flip the lever to activate the syringe after flushing has been started on the touchscreen.

①	Turbine hose without coupling
②	Motor without contra-angle
③	Scaler hose without handpiece
④	Syringe



Once all instruments have been taken out, you can confirm the flushing process.



Confirm



The flushing time (120 s) is indicated on the display.



Once all the instruments have been flushed, activate the cup filler.



You can find an application film at www.youtube.com/DKL_Germany.
Video: FUNCTIONS FLUSHING INSTRUMENTS WITH WATER SEPARATION UNIT WSU

LINK: https://youtu.be/oGBu3bN_qpo

Intensive Flushing with the Water Separation Unit (WSU)



After longer downtimes such as weekends or holidays, we recommend flushing the water lines intensively before starting work.



The push-button lights up blue: intensive flushing has started. Double click on the button of the cuspidor to activate intensive flushing. Intensive flushing is carried out in two phases. During the first phase with double dosage, the push-button of the WSU flashes blue. During the second phase, the rinsing phase, the push-button of the water separation unit flashes blue-green up to the end of the intensive flushing process.



Open the menu "Flushing" on the touchscreen



Select INTENSIVE Flushing



Message: Take out all the instrument tubes



Use the hygiene cover



Confirm



The flushing time "Intensive" is indicated on the display.



After completion of the intensive flushing, the push-button of the cuspidor lights up green for normal operation. Remove the instrument tubes from the hygiene cover and put them back into their holders.

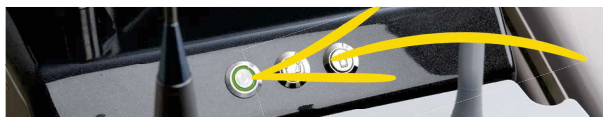

While intensive flushing is activated (push-button lights up blue) do not work on the patient.



Once all the instruments have been flushed, activate the cup filler.



You can find application films at www.youtube.com DKL Germany.
Playlist: DKL CHAIRS L2-D2 SERIES WATER SEPARATION UNIT (WSU)

LINK: <https://www.youtube.com/playlist?list=PLBx4baZAs6WgFfb2fwSJmG1tyqFaoX19s>

Documentation of instrument flushing NORMAL and INTENSIVE



The documentation of the instrument flushing NORMAL and INTENSIVE can be activated, deactivated, retrieved and exported to a USB stick via the system settings in the display in the menu SYSTEM → SYSTEM INFO (2nd page) → FLUSHING HISTORY.

Filling DK-DOX 150 into the Water Separation Unit



DK-DOX 150 is used to maintain the quality of the water supplied to DKL dental units. DK-DOX 150 is a pH-neutral, chlorine-free, aqueous chlorine dioxide solution and is used in the water separation unit with a mixing ratio of 0.75mg/l. The product is not classified as a hazardous substance.

DK-DOX 150 bottle Content 250 ml, product number 590007

Shop: <https://dkl.de/en/DK-DOX-150-Set-of-6-bottles-250-ml-each/590007>

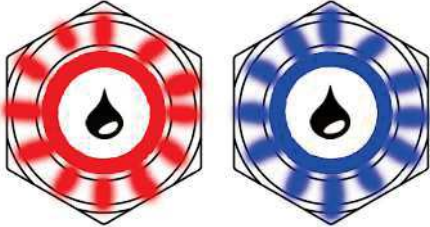

Push-button flashes red/blue:
DK-DOX 150 must be refilled.

Open the cover of the storage container for the water separation unit at the base of the cuspidor.

You can find an application film at www.youtube.com
DKL Germany. Video: DKL CHAIRS L2-D2 SERIES
FILLING DK-DOX 150 WATER SEPARATION UNIT
(WSU)



LINK: <https://youtu.be/CObils6gklQ>



Do not fill any other agents into the storage container of the water separation unit. Only refill with DK-DOX150!

Open the cap of the storage container. Fill in 250 ml DK-DOX 150. Make sure that the glass bowl in the storage container does not overflow. After filling, put the cap back on the storage container and close the cover again. The water separation unit automatically returns to normal operation. The button lights up green.



Setting Media Instruments

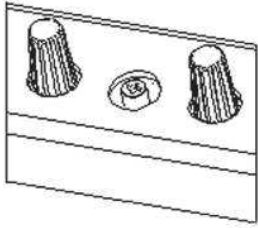

Below the doctor's device, the spray intensity can be regulated. The valve groups (3-fold) for an instrument are arranged according to the order of the instruments in the instrument holders.

The spray intensity can be adjusted with the control knobs. The operating air for the turbine or the cooling air for the motor can be adjusted with a Phillips screwdriver.

Symbols at the Regulators



Spray air



Spray water



Operating air turbine or cooling air motor

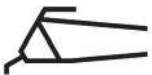

Syringe



Piezo scaler

Maintenance and Inspection



In order to ensure the operational and functional reliability of your treatment unit and to avoid damage due to wear and tear it is necessary to perform maintenance once a year. Maintenance is carried out by an authorised technician of your specialist dealer or a DKL CHAIRS technician.

The work steps to be performed and the parts to be replaced are specified in the document "Maintenance Log". The tasks that were performed have to be entered in the maintenance log, which is part of the medical devices logbook.

Safety Inspections



Dental units are designed in such a way that a first fault does not present a hazard to patients, operators or third parties. Therefore, it is important to detect such faults before a second fault occurs, which may result in a hazard.

For this reason, safety inspections should be carried out every 3 years to detect electrical faults in particular (e.g. faulty electrical insulation). These checks are carried out by an authorised technician of your specialist dealer or a DKL CHAIRS technician.











The work steps to be performed are specified in the document "Safety Inspections". The measured values have to be documented.

Safety inspections have to be carried out when putting your treatment unit into initial operation, after expansion or retrofitting activities on your treatment unit and after repair jobs. The safety inspections are carried out in accordance with DIN EN 62353.











The treatment unit may only be operated when the safety checks have been passed.

Error Messages

Icon	Error description	Remedy
	Battery of the foot controller almost empty.	Change the battery in the foot controller. The message on the display can be acknowledged.
	Instrument is not found.	 Call customer service.
	Several instruments have been taken out.	Check whether the instruments are properly inserted in the instrument holders.
	Pump is not recognised.	In the applications turbine, motor and scaler, the message can be acknowledged. The system switches automatically to the coolant water. With the option "Implantmed-motor" the pump is obligatory. Otherwise, the Implantmed motor cannot be used.  Call customer service.
	Temperature of the drive motor for the treatment chair is too high.	Acknowledge the error message on the display. Let the motors cool down for about 10 minutes.
	Defect in the controls of the treatment chair.	Message can be acknowledged on the display. The treatment chair can be moved manually in the emergency mode.  Call customer service.
	Voltage fluctuations.	Switch off the treatment unit. Switch the treatment unit on again after 1 minute. If the error message appears again after this restart,  Call customer service.

Error Messages

Icon	Error description	Remedy
	Warning foot controller	> Check plug connection of the dongle.
	Warning motor	> Check plug connection of the motor > Let the motor cool down for at least 10 minutes.
	Warning USB storage device > Not enough memory > Unknown file system > Write protection is active	Plug in USB-stick with sufficient memory.
	Warning overheating	> Switch off the treatment unit. > Let the treatment unit cool down for at least 10 minutes. > Switch on the treatment unit. If the error message appears again after restarting the unit,  call customer service.
	Warning timeout	Let the micromotor cool down for at least 10 minutes.
	System error	Switch off the treatment unit. After 1 minute, switch the treatment unit on again. If the error message appears again after restarting the unit,  call customer service.

Warranty Declaration



12 Months Warranty

This DKL medical product has been manufactured with the utmost care by highly qualified specialists. Multifarious checks and inspections ensure faultless performance. Please note that warranty claims will only be accepted if all the instructions in this operating manual have been observed.

DKL as the manufacturer shall be liable for material and manufacturing faults within a warranty period of 12 months from the date of purchase. Accessories and consumables (seals, filters, lamps and suction tubes) are excluded from this warranty. We do not accept liability for damages caused by improper treatment or repair work carried out by third parties that are not authorised by DKL!

Any warranty claims must be filed with the supplier or an authorised DKL service partner and the sales slip must be enclosed. Any performance of this warranty does not extend the warranty period.

To protect your warranty claims and guarantee safe operation, medical devices must be installed properly, and staff must be instructed. To be able to proof this, information for assembly, initial start-up and instructions must be documented. For this purpose, please use our L2-D2 series certificate of delivery. After putting the device into operation, please return the completed certificate to us as proof.

Waste Disposal



Make sure that the parts that are being disposed of are not contaminated.



Observe your local and national laws, guidelines, standards and regulations for disposal.

- > Medical devices
- > Waste electrical and electronic equipment



Further information on disposal can be found at <http://dkl.de>



Disposal and recycling of DKL transport packaging is carried out within the scope of the Dual System via the local waste disposal and recycling companies.

DKL transport packaging returned by customers at their own expense is supplied by DKL to the recycling companies set up for this purpose without further costs and without reimbursement.

EMC - Manufacturer's Declaration for the Model D2-AVEO

- **WARNING:** The use of accessories that do not conform to the manufacturer's specifications may result in higher interference levels and/or lower interference immunity.
- Operate the equipment in a location as far away as possible from equipment that emits electrical and magnetic disturbances. If it is necessary to operate the device in the immediate vicinity of other devices, make sure that the system functions correctly.

BASIC SAFETY

BASIC SAFETY is ensured if it meets the safety requirements of the IEC 60601-1 standard, in particular the requirements against: electrical shock, mechanical hazards and hazards due to excessive temperatures.

ESSENTIAL PERFORMANCE

The dental unit has no direct clinical function or essential performance according to IEC 60601-1, IEC 80601-2-60, 201.4.3 ESSENTIAL PERFORMANCE.

Performance limitations are permitted according to the following criteria. This is considered in the risk analysis of the system.

Criterion A

The dental unit will withstand the test without damage or other interference. During and after the test, the device will operate perfectly within the specified limits. Basic safety is guaranteed throughout.

Criterion B

The dental unit will withstand the test without damage or other interference. After the test, the device will operate perfectly within the specified limits. Basic safety is guaranteed throughout.

Criterion C

A temporary malfunction is permitted if the function resets itself or if it can be restored by user intervention. Basic safety is guaranteed throughout.

Intended operating environment

Intended operating environments are typical professional health care facilities and areas of home health care.

Technical description

This dental unit has been tested and developed to meet the EMC behaviour in the specified environment. This includes special EMC-filters to reduce the radiation of electromagnetic waves as defined in IEC 60601-1-2.

Please read and follow all technical documentation to avoid adverse events for the patient or user.

IEC STANDARD 60601-1-2:2014, 4th Edition

This device is approved for use in a specific electromagnetic environment. The customer or user of the device must ensure that it is used in an electromagnetic environment in accordance with the description given below.

Emission Measurement	Agreement	Guidelines Regarding the Electromagnetic Environment
RF-emission according to CISPR 11	Group 1	This device uses RF-energy for internal functions only. RF-emissions are therefore very low, and it is unlikely that other nearby electronic equipment will be disturbed. The device is suitable for use in all environments, including residential areas, and approved for direct connection to the public low-voltage network for residential areas.
RF-emission according to CISPR 11	Class B	
Harmonics according to IEC 61000-3-2	Class A	
Voltage fluctuations/ flicker according to IEC 61000-3-3	met	

Interference Immunity Test	IEC 60601-test level	Compliance level	Electromagnetic Environment - Guidelinesf
Electrostatic Discharge (ESD) according to IEC 61000-4-2	± 8 kV contact discharge ±2, 4, 8, 15 kV air discharge	± 8 kV contact discharge ±15 kV air discharge	The floor should be wood, concrete or tiles. If the floor is covered with synthetic material, the relative humidity should be at least 30%. Criterion B
Fast transient electrical disturbances/bursts according to IEC 61000-4-4 (only for V 300/600)	± 2 kV for mains 100 kHz repeat rate	± 2 kV for mains 100 kHz repeat rate	The quality of the mains power supply should meet the requirements for a normal commercial or clinical environment. Criterion B
Surge voltages according to IEC 61000-4-5 (only for V 300/600)	± 0,5 kV , ± 1 kV L to N ± 0,5 kV , ± 1 kV ± 2 kV L to GND	± 1 kV L to N ± 2 kV L to GND	The quality of the mains power supply should meet the requirements for a normal commercial or clinical environment. Criterion B
Voltage dips, short-term interruptions and voltage fluctuations of the mains supply lines according to IEC 61000-4-11 (only for V 300/600)	0 % UT 0°,45°,90°,135°,180°,225°,270°,315° 0 % UT 0° 0% 70 % UT 0 % UT 0%	0 % UT for 1/2 Period 1 Period 25 /30 Periods (50/60Hz) 250/300 Periods (50/60Hz) for 5 s	The quality of the mains power supply should meet the requirements for a normal commercial or clinical environment. If the user of the product requires continuous operation even with interruptions of the power supply, the product should be connected to an uninterruptible power supply. Criterion A (max. mains voltage) Criterion B (min. mains voltage) Criterion A (max. mains voltage) Criterion B (min. mains voltage) Criterion A (max. mains voltage) Criterion B (min. mains voltage) Criterion A (max. mains voltage) Criterion B (min. mains voltage)
Magnetic field at the mains frequency (50/60 Hz) according to IEC 61000-4-8	30 A/m	30 A/m	Magnetic fields at the mains frequency should have levels typical of an application in a commercial or clinical environment.

Note: UT is the alternating mains voltage prior to the application of the test level.

Specifications for Enclosure Port Immunity

Immunity Test	Test condition	IEC 60601 level of conformity	Electromagnetic Environmental Recommendation
Radiated electromagnetic fields from high-frequency wireless communication devices IEC 61000-4-30-4-3	10 V/m 80 MHz – 2,7 GHz 80% AM 1kHz	10 V/m 80 MHz – 2,7 GHz	The quality of the main power supply should correspond to the one for a professional health care facility and be appropriate regarding the environment in areas of domestic health care. Criterion A
	385MHz (18Hz pulse modulation)	27 V/m	
	450MHz (FM+/-5KHz deviation 1kHz sine or 18Hz pulse modulation)	28 V/m	
	710MHz (217Hz PM)	9 V/m	
	745MHz (217Hz PM)	9 V/m	
	780MHz (217Hz PM)	28 V/m	
	810MHz (18Hz PM)	28 V/m	
	870MHz (18Hz PM)	28 V/m	
	930MHz (18Hz PM)	28 V/m	
	1720MHz (217Hz PM)	28 V/m	
	1845MHz (217Hz PM)	28 V/m	
	1970MHz (217Hz PM)	28 V/m	
	2450MHz (217Hz PM)	28 V/m	
	5240MHz (217Hz PM)	9 V/m	
5500MHz (217Hz PM)	9 V/m		
5785MHz (217Hz PM)	9 V/m		

Interference immunity test	IEC 60601-test level	Compliance level	Electromagnetic environment - guidelines
Conducted RF-disturbance variables according to IEC 61000-4-6 (only for V 300/600) Radiated RF-disturbance variables and near fields from wireless communication equipment according to IEC 61000-4-3	3 Veff 150 kHz to 80 MHz 10 V/m 80 MHz to 2,7 GHz	10 Veff 10 V/m	The distance between portable or mobile RF-communications equipment and parts of the product, including cables, should not be less than the recommended protective distance calculated with the equation applicable to the transmission frequency. Recommended protective distance: $d = 1,2\sqrt{P}$ $d = 1,2\sqrt{P}$ for 80 MHz to 800MHz $d = 2,3\sqrt{P}$ for 800 MHz to 2.7 GHz Here P is the maximum nominal power output of the transmitter in watts (W) according to the transmitter manufacturer's specifications, and d is the recommended distance in metres (m). The field strength of permanently installed RF-transmitters, which was determined by an electromagnetic location test ^a should not exceed the level ^b permitted in any frequency range. Interference may occur in the immediate vicinity of equipment marked with the following symbol: 

Note 1: At 80 MHz and 800 MHz respectively, the larger frequency range applies.

Note 2: These guidelines may not apply to all situations. The propagation of electromagnetic waves is affected by the absorption and reflection of structures, objects, people and animals.

^a The field strength of permanently installed transmitters, such as base stations for radio telephony (cordless or mobile phones), mobile radio stations, amateur radio transmitters, AM and FM radio and television transmitters, cannot theoretically be calculated with absolute accuracy. To determine the electromagnetic fields generated by fixed RF-transmitters, an electromagnetic site inspection should be carried out. If the measured field strength at the location where the device is used exceeds the permissible RF-field strength specified above, the instrument should be observed. Additional measures may be necessary, e.g. reorientation or change of location of the device.

^b In the frequency range between 150 kHz and 80 MHz, the field strength should be less than 3 V/m.

Manufacturer's Declaration - Electromagnetic Interference Immunity III

The device is approved for use in a specific electromagnetic environment.

The customer or user of the device must ensure that it is used in an electromagnetic environment as described below.

Interference Immunity Test	IEC 60601-test level	Compliance level	Electromagnetic environment – guidelines
Fluctuations in the mains frequency and mains voltage according to IEC 601-1, section 10.2.2. a (only for V 300/600)	Nominal frequency: up to 100 Hz: variations of ± 1 Hz of the nominal frequency; variations of $\pm 10\%$ Hz of the nominal voltage	Nennfrequenz: bis zu 100 Hz: Schwankungen von ± 1 Hz der Nennfrequenz; Schwankungen von $\pm 10\%$ Hz der Nennspannung	The quality of the mains voltage supply should meet the requirements of a normal commercial or clinical environment.

Manufacturer's Declaration - Recommended Protective Distances between Portable or Mobile RF-Communication Equipment and the Device

The device is intended for use in an electromagnetic environment where the radiated RF-disturbance variables are checked. The customer or user of the device can help to prevent electromagnetic interference by maintaining a minimum distance between portable and mobile RF-communication equipment (transmitters) and the device in accordance with the following recommendations, which are based on the maximum output power and frequency of the communication device.

Maximum nominal power of the transmitter in watts (W)	Protective distance as a function of the frequency of the transmitter in metres (m)		
	150 kHz to 80 MHz $d = 1,2\sqrt{P}$	80 MHz to 800 MHz $d = 1,2\sqrt{P}$	800 MHz to 2,5 GHz $d = 2,3\sqrt{P}$
0,01	0,12	0,12	0,23
0,1	0,38	0,38	0,73
1	1,2	1,2	2,3
10	3,8	3,8	7,3
100	12	12	23

For transmitters with a maximum output power not specified above, the recommended safety distance d in meters (m) can be calculated with an equation from the transmitter frequency and the maximum nominal output power P of the transmitter in watts (W) based on the transmitter manufacturer's specifications.

Note 1: At 80 MHz and 800 MHz respectively, the larger frequency range applies.

Note 2: These guidelines may not apply to all situations. The propagation of electromagnetic waves is affected by the absorption and reflection of structures, objects, people and animals.

ATTENTION: The use of this device directly adjacent to or coupled to another unit should be avoided as it may lead to unintentional behaviour. However, if this arrangement is unavoidable, both devices must be observed to verify that they are functioning normally.

CAUTION: Portable RF-communication equipment (including antenna cables or external antennas) should not be closer than 30 cm to the ME-equipment or ME-system, including those cables specified by the manufacturer. Otherwise, a power limitation of the device could be caused.

Instructions for use



CE
0297



Electric motor
EM-11 L / EM-12 L
Supply hose
VE-10 / VE-11

Contents

Symbols	4
1. Introduction	7
2. Safety notes	10
3. Product description	14
4. Operation	16
Screw on the motor	16
Unscrew the motor.....	17
Test run	19
5. Hygiene and maintenance	20
General notes	20
Limitations on processing.....	22
Initial treatment at the point of use.....	23
Manual cleaning.....	24
Cleaning of the optic outlet	25

Manual disinfection	26
Drying	27
Inspection, Maintenance and Testing.....	28
Packaging.....	29
Sterilization	30
Storage.....	32
6. Maintenance	33
7. Servicing.....	36
8. W&H Accessories and spare parts	38
9. Technical data.....	39
10. Data on electromagnetic compatibility according to IEC/EN 60601-1-2.....	41
11. Disposal.....	46
Explanation of warranty terms.....	47
Authorized W&H service partners	48

Symbols

in the Instructions for use



WARNING!
(risk of injury)



ATTENTION!
(to prevent
damage occurring)



General explanations,
without risk to
persons or objects















Do not dispose of
with domestic waste

R_x_{only}

Caution!
Federal law restricts this device to sale by or on the order of a dentist, physician, veterinarian or with the descriptive designation of any other practitioner licensed by the law of the State in which the practitioner practices to use or order the use of the device.

Symbols

on the motor / packaging

	CE marking with identification number of the Notified Body		DataMatrix Code for product information including UDI (Unique Device Identification)		Data structure in accordance with Health Industry Bar Code
	Consult Instructions for Use		Sterilizable up to the stated temperature		Date of manufacture
	Catalogue number		Permitted temperature range		Medical Device
	Serial number		UL Component Recognition Mark indicates compliance with Canadian and U.S. requirements		Manufacturer
	Humidity limitation				

Symbols

on the supply hose



CE marking
with identification number
of the Notified Body



Type B applied part (not
suitable for intracardiac
application)



Medical Device



Catalogue number



Serial number

1. Introduction

Customer satisfaction has absolute priority in the W&H quality policy. This medical device has been developed, manufactured and subjected to final inspection according to legal regulations, quality and industry standards.

For your safety and the safety of your patients

Prior to initial use please read the Instructions for use. These explain how to use your medical device and guarantee a smooth and efficient operation.



Observe the safety notes.

Intended use

Electrical drive, including the supply of cooling media, for dental transmission instruments used in the field of preventive dentistry, restorative dentistry such as cavity preparation and prosthodontics such as crown preparation.



Misuse may damage the medical device and hence cause risks and hazards for patient, user and third parties.

Qualifications of the user

We have based our development and design of the medical device on the dentists, dental hygienists, dental employees (prophylaxis) and dental assistants target group.

Responsibility of the manufacturer

The manufacturer can only accept responsibility for the safety, reliability and performance of the medical device when it is used in compliance with the following directions:

- > The medical device must be used in accordance with these Instructions for Use.
- > The medical device has no components that can be repaired by the user.
Modifications or repairs must only be undertaken by an authorized W&H service partner (see page 48).

Skilled application

The medical device is intended only for skilled application according to the intended use as well as in compliance with the valid health and safety at work regulations, the valid accident prevention regulations and in compliance with these Instructions for Use.

The medical device should be prepared for use and maintained by staff who have been trained in procedures for infection control, personal safety and patient safety.

Improper use, (e.g., through poor hygiene and maintenance), non-compliance with our instructions or the use of accessories and spare parts which are not approved by W&H, invalidates all claims under warranty and any other claims.



Any serious incident that has occurred in relation to the medical device should be reported to the manufacturer and the competent authority!

2. Safety notes



- > Before using the medical device for the first time, store it at room temperature for 24 hours.
- > Always ensure the correct operating conditions and cooling function.
- > Always ensure that sufficient and adequate cooling is delivered and ensure adequate suction.
- > In case of coolant supply failure, the medical device must be stopped immediately.
- > Check the medical device for damage and loose parts each time before using.
- > Do not operate the medical device if it is damaged.
- > Use only the filtered, oil-free and cooled air supplied by dental compressors for drive air.
- > Perform a test run each time before using.
- > Do not look directly into the light source.
- > Never touch the patient and the electrical contacts on the medical device simultaneously.



- > The medical device is not approved for operation in potentially explosive atmospheres.
- > The operation of the medical device is permitted only on supply units which correspond to the standards IEC 60601-1 (EN 60601-1) and IEC 60601-1-2 (EN 60601-1-2).



- > Moisture in the medical device may cause a malfunction. (Risk of short circuit)
- > The medical product is lubricated for life and therefore should not be lubricated.
- > Do not twist, kink or squeeze the supply hose (risk of damage).
- > Replace damaged or leaking O-rings immediately.
- > The medical device is tailored to the W&H supply hose and the W&H control electronics and must therefore only be used with W&H products. Using other components could lead to deviating parameters or even the destruction of the system.

**Risks due to electromagnetic fields**

The functionality of implantable systems, such as cardiac pacemakers and implantable cardioverter defibrillators (ICD) can be affected by electric, magnetic and electromagnetic fields.

- > Find out if patient and user have implanted systems before using the medical device and consider the application.
- > Weigh the risks and benefits.
- > Keep the medical device away from implanted systems.
- > Do not place the motor on the patient's body.
- > Make appropriate emergency provisions and take immediate action on any signs of ill-health.
- > Symptoms such as raised heartbeat, irregular pulse and dizziness can be signs of a problem with a cardiac pacemaker or ICD.

**Rotational energy**

Fast deceleration of the bur can, at times, cause the selected torque to be temporarily exceeded, compared to the value set, as a result of the rotational energy stored in the drive system.

**Transmission instruments**

- > Follow the directions and safety notes in the Instructions for Use of the transmission handpieces.
- > Only use transmission instruments with an ISO 3964 (DIN 13940) compatible coupling system and manufacturer approved transmission instruments.
- > Follow the directions of the manufacturer of transmission handpieces with reference to transmission ratio, maximum speed and maximum torque.

**Hygiene and maintenance prior to initial use**

- > The medical device is sealed in PE film and not sterilized when delivered.
- > The PE film and the packaging are non-sterilizable.

- > Clean and disinfect the medical device.
- > Sterilize the medical device.

3. Product description

Motor

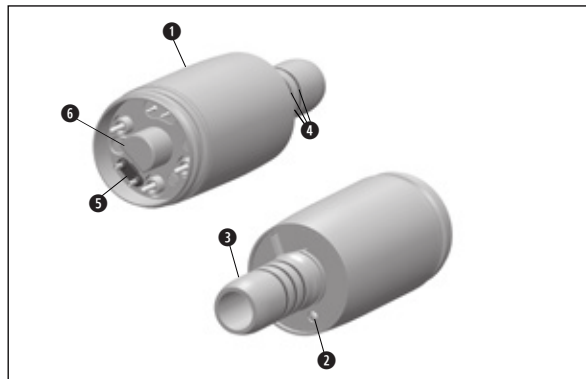

- ① Motor sheath
- ② LED
- ③ Connection for instruments
as per ISO 3964
- ④ O-rings
- ⑤ Seal
- ⑥ Alignment pin (only for EM-11 L)

Product description

Supply hose

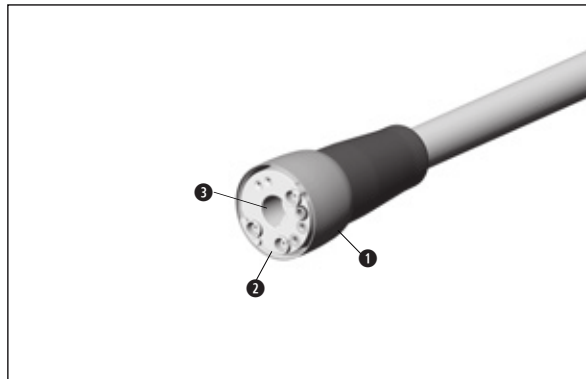

- ❶ Tubing sleeve
- ❷ Connection
- ❸ Alignment hole (only for EM-11 L)

4. Operation

Screw on the motor

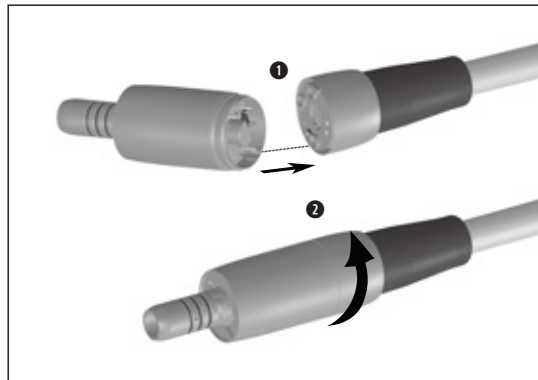

! Do not assemble or remove the medical device during operation!

- 1 Push the motor onto the supply hose.
Note the alignment aids
- 2 Screw the tubing sleeve and the motor together.

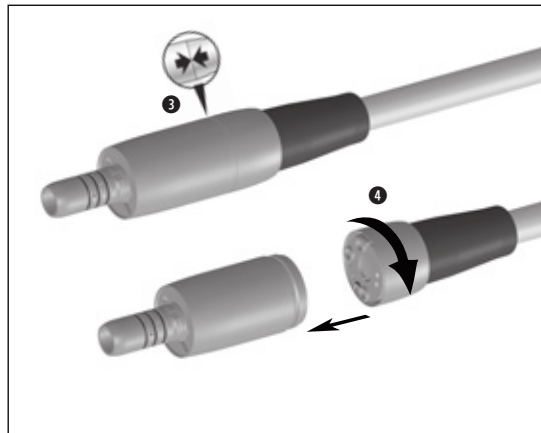

- 3 Carry out a visual inspection. The motor and the tubing sleeve coupling must sit flush to one another.



Verify full engagement.

Unscrew the motor

- 4 Unscrew the supply hose from the motor.

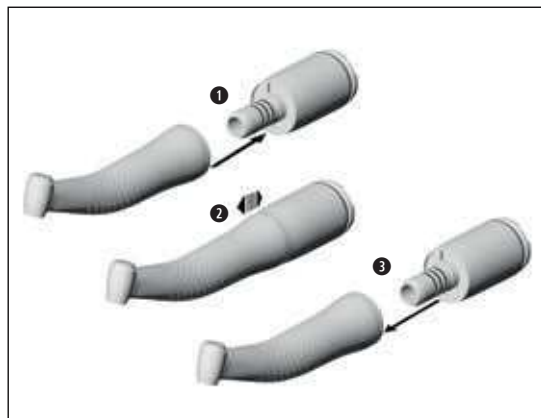

Assembly and removal of transmission instruments



Do not assemble or remove the medical device during operation!

- 1 Push the transmission instrument onto the motor and turn it until it engages audibly.



2 Verify full engagement.

- 3 Remove the transmission instrument from the motor.

Test run



> Do not hold the medical device at eye level.

> Start the medical device using the attached transmission instrument.



In the event of operating malfunctions (e.g., vibrations, unusual noise, overheating, coolant failure or leakage) **stop the medical device immediately** and contact an authorized W&H service partner.

5. Hygiene and maintenance

General notes



Follow your local and national laws, directives, standards and guidelines for cleaning, disinfection and sterilization.



- > Wear protective clothing, safety glasses, face mask and gloves.
- > Remove the transmission instrument from the medical device.
- > Use only oil-free, filtered compressed air with a maximum operating pressure of 3 bar for manual drying.



- > The motor is not approved for automated processing in a washer-disinfector.
- > Note the dental manufacturer's reprocessing instructions for the supply hose.
- > The supply hose is not approved for automated processing in a washer-disinfector and sterilization.



Cleaning agents and disinfectants

- > Read the notes, follow the instructions and heed the warnings provided by the manufacturers of cleaning agents and/or disinfectants.
- > Use only detergents which are intended for cleaning and/or disinfecting medical devices made of metal and plastic.
- > It is imperative to comply with the concentrations and exposure times specified by the manufacturer of the disinfectant.
- > Use disinfectants which have been tested and found effective by the Verbund für Angewandte Hygiene e.V. (VAH = Association for Applied Hygiene), the Österreichischen Gesellschaft für Hygiene, Mikrobiologie und Präventivmedizin (ÖGHMP = Austrian Society for Hygiene, Microbiology and Preventive Medicine), the Food and Drug Administration (FDA) and the U.S. Environmental Protection Agency (EPA).



The user is responsible for validating its process if the specified cleaning agents and disinfectants are not available.

Hygiene and maintenance

Limitations on processing



The product lifetime and the medical device's ability to operate correctly are mainly determined by mechanical stress during use and chemical influences due to processing.

- > Send worn or damaged medical devices and/or medical devices with material changes to an authorized W&H service partner.



Processing cycles

- > We recommend a regular service for the W&H motor after 500 processing cycles or one year.

Hygiene and maintenance

Initial treatment at the point of use



- > Remove the motor from the supply hose.
- > Clean the medical device immediately after every treatment.



Note that the disinfectant used during pre-treatment is only for personal protection and cannot replace the disinfectant step after cleaning.



Do not place the medical device in liquid disinfectant or in an ultrasonic bath.

- > Clean the medical device under running tap water (< 35 °C / < 95 °F).
- > Rinse and brush off all internal and external surfaces.
- > Remove any liquid residues using compressed air.

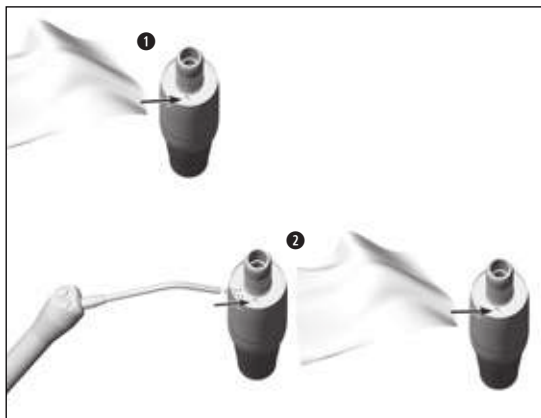

Cleaning of the optic outlet



Avoid scratching the light source!



- 1 Wash the optic outlet with cleaning fluid and a soft cloth.
- 2 Blow the optic outlet dry with compressed air or dry it carefully with a soft cloth.



Carry out a visual inspection after each cleaning process. Do not use the medical device if the light source is damaged and contact an authorized W&H service partner.

Hygiene and maintenance

Manual disinfection

-  > W&H recommends wiping down with disinfectant.
-  Evidence of the medical device's basic suitability for effective manual disinfection was provided by an independent test laboratory using the disinfectants "mikrozyd® AF wipes" (Schülke & Mayr GmbH, Norderstedt) and "CaviWipes™" (Metrex).

Hygiene and maintenance

Drying



- > Ensure that the medical device is completely dry internally and externally after cleaning and disinfection.
- > Remove liquid residues using compressed air.

Inspection



- > Check the medical device after cleaning and disinfection for damage, visible residual soiling and surface changes.
- > Reprocess any medical devices that are still soiled.
- > Sterilize the motor following cleaning, disinfection.



Pack the medical device in sterilization packaging that meet the following requirements:

- > The sterilization package must meet the applicable standards in respect of quality and use and must be suitable for the sterilization method.
- > The sterilization package must be large enough for the sterilization goods.
- > The filled sterilization package must not be under tension.



W&H recommends sterilization according to EN 13060, EN 285 or ANSI/AAMI ST55.



- > Read the notes, follow the instructions and heed the warnings provided by the manufacturers of steam sterilizers.
- > The program selected must be suitable for the motor.

Recommended sterilization procedures

- > “Dynamic-air-removal prevacuum cycle” (type B) / “Steam-flush pressure-pulse cycle” (type S)*/**
134°C (273°F) for at least 3 minutes, 132°C (270°F) for at least 4 minutes
- > “Gravity-displacement cycle” (type N)**
121°C (250°F) for at least 30 minutes
- > Maximum sterilization temperature 135°C (275°F)



Evidence of the medical device's basic suitability for effective sterilization was provided by an independent test laboratory using the LISA 517 B17L* steam sterilizer (W&H Sterilization S.r.l., Brusaporto (BG)), the Systec VE-150* steam sterilizer (Systec) and the CertoClav MultiControl MC2-S09S273** steam sterilizer (CertoClav GmbH, Traun).

"Dynamic-air-removal prevacuum cycle" (type B):	134°C (273°F) – 3 minutes*, 132°C (270°F) – 4 minutes*/**
"Steam-flush pressure-pulse cycle" (type S):	134°C (273°F) – 3 minutes*, 132°C (270°F) – 4 minutes*/**
"Gravity-displacement cycle" (type N):	121°C (250°F) – 30 minutes**

Drying times:

"Dynamic-air-removal prevacuum cycle" (type B):	132°C (270°F) – 30 minutes**
"Steam-flush pressure-pulse cycle" (type S):	132°C (270°F) – 30 minutes**
"Gravity-displacement cycle" (type N):	121°C (250°F) – 30 minutes**

* EN 13060, EN 285, ISO 17665

** ANSI/AAMI ST55 , ANSI/AAMI ST79

Hygiene and maintenance

Storage



- > Store sterile goods dust-free and dry.
- > The shelf life of the sterile goods depends on the storage conditions and type of packaging.

6. Maintenance

Exchanging the motor O-rings

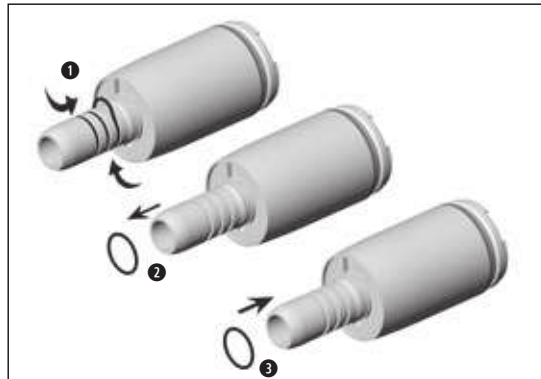

! Replace damaged or leaking O-rings immediately. Do not use sharp tools!

- 1 Squeeze the O-ring together between thumb and forefinger to form a loop.
- 2 Pull off the O-rings.
- 3 Slide on the new O-rings.

☞ Always change all three O-rings at the same time in order to ensure the tightness of the motor.

Maintenance

Replacing the seal

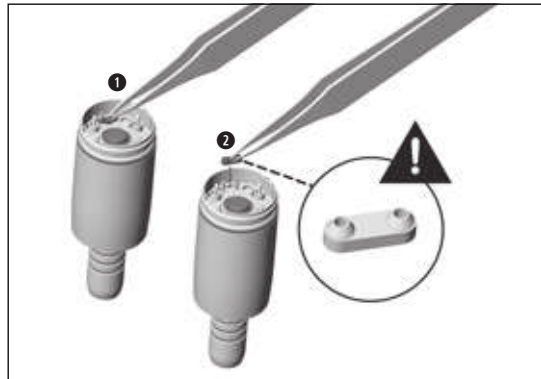

- 1 Lift up the seal with the tip of a pair of tweezers. Remove the seal.
- 2 Carefully insert the new seal.

 Pay attention to the positioning of the seal.

Maintenance

Exchanging the supply hose O-ring

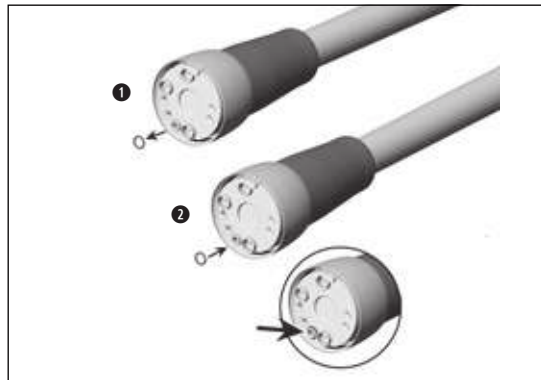

! Replace damaged or leaking O-rings immediately. Do not use sharp tools!

- 1 Pull off the O-ring.
- 2 Slide on the new O-ring.

7. Servicing



Periodic inspection

Regular periodic inspection of the function and safety of the medical device is necessary and should be carried out at least once every three years, unless shorter intervals are prescribed by law. The periodic inspection covers the complete medical device and must only be performed by an authorized service partner.

Repairs and returns

In the event of operating malfunctions immediately contact an authorized W&H service partner.
Repairs and maintenance work must only be undertaken by an authorized W&H service partner.



> Ensure that the medical device has been completely processed before returning it.

8. W&H Accessories and spare parts



Use only original W&H accessories and spare parts or accessories approved by W&H.

Suppliers: W&H service partners

01862300	Motor O-rings (3 pcs)
06893400	Seal (1 pcs)
07072400	Supply hose O-ring (1 pcs)

9. Technical data

Motor	EM-11 L	EM-12 L
Approved supply hose	VE-11	VE-10 / VE-11
Transmission instrument according to standard	ISO 3964	
Direction of rotation	forward/reverse	
Speed range	2,000 – 40,000 rpm	100 – 40,000 rpm
Maximum torque at the motor	3 Ncm	
Adjustment cooling air	6 – 8 l/min	
Air coolant pressure* The air coolant pressure has to be higher than the water coolant pressure	0.5 – 3.0 bar	
Water coolant volume at (0,5 bar)	> 60 ml/min	
Water coolant pressure*	0.5 - 3.0 bar	

* Adjust the actual pressure with an attachment in place.

Technical data

Supply hose	VE-10	VE-11
Approved electric motor	EM-12 L	EM-11 L / EM-12 L
Drive air respective cooling air at 250 kPa (2,5 bar)		> 8 NI/min
Spray air at 250 kPa (2,5 bar)		> 8 NI/min
Spray water at 200 kPa (2,0 bar)		> 200 ml/min
Maximum pressure		400 kPa (4.0 bar)

10. Data on electromagnetic compatibility according to IEC/EN 60601-1-2

Operating environment and EMC warning notes

This medical device is neither life-sustaining nor coupled to the patient. It is suitable for operation both in domestic healthcare and in facilities used for medical purposes except rooms/areas, in which EMC interference of high intensity may occur.

The customer and/or the user should assure that this medical device is set up and used in an environment of the specified type and/or in accordance with the specifications of the manufacturer. This medical device uses RF energy only for its internal functions.

No special precautions are necessary to maintain the basic safety and essential performance of this medical device.

Essential performance

This medical device has no critical functions and therefore does not have any essential performance features.



Portable RF communication devices

Portable RF communications equipment (including peripherals such as antenna cables and external antennas) should be used no closer than 30 cm (12 inches) to the medical device. Otherwise, degradation of the performance of this medical device could result.



W&H guarantees the compliance of the device with the EMC requirements only when used with original W&H accessories and spare parts. The use of accessories and spare parts not approved by W&H can lead to an increased emission of electromagnetic interference or to a reduced resistance against electromagnetic interference.



Use of this medical device adjacent to or stacked with other equipment should be avoided because it could result in improper operation. If such use is necessary, this medical device and the other equipment should be observed to verify that they are operating normally.



The medical device is not intended for use in the vicinity of HF surgical devices.

Results of the electromagnetic tests

Requirement	Class / Test Level*
Electromagnetic emissions	
Mains terminal disturbance voltage (Conducted Emissions) CISPR 11/EN 55011 [150 kHz – 30 MHz]	Group 1 Class B
Electromagnetic radiation disturbance (Radiated Emissions) CISPR 11/EN 55011 [30 MHz – 1000 MHz]	Group 1 Class B
Harmonic distortion IEC/EN 61000-3-2	Class A
Immunity to electromagnetic interference	
Electrostatic discharge (ESD) IEC/EN 61000-4-2	Contact discharge: ± 8 kV Air discharge: ± 2/4/8/15 kV
Radiated RF electromagnetic field IEC/EN 61000-4-3 [80 MHz – 2,7 GHz]	10 V/m

* There are no deviations or simplifications to IEC 60601-1-2.

Proximity fields from RF wireless communications equipment IEC/EN 61000-4-3	385 MHz	27 V/m
	450 MHz	28 V/m
	710 / 745 / 780 MHz	9 V/m
	810 / 870 / 930 MHz	28 V/m
	1720 / 1845 / 1970 MHz	28 V/m
	2450 MHz	28 V/m
	5240 / 5500 / 5785 MHz	9 V/m
Electrical fast transient/burst IEC/EN 61000-4-4 Electrical cables Input and output cables	±2 kV ±1 kV	
Conducted disturbances induced by RF fields IEC/ EN 61000-4-6	3 V 6 V in ISM bands 6 V in amateur radio bands	
Power frequency magnetic field EN 61000-4-8	30 A/m	

**Temperature information**

Temperature of the medical device on the operator side: maximum 56°C (133°F)

Ambient conditions

Temperature during storage and transport:	-40°C to +70°C (-40°F to +158°F)
Humidity during storage and transport:	8% to 80% (relative), non-condensing
Temperature during operation:	+10°C to +35°C (+50°F to +95°F)
Humidity during operation:	15% to 80% (relative), non-condensing
Altitude:	up to 3,000 m above sea level

11. Disposal



Ensure that the parts are not contaminated on disposal.



Follow your local and national laws, directives, standards and guidelines for disposal.

- > Medical device
- > Waste electrical equipment
- > Packaging

Explanation of warranty terms

This medical device has been manufactured with great care by highly qualified specialists. A wide variety of tests and controls guarantee faultless operation. Please note that claims under warranty can only be validated when all the directions in the Instructions for use have been followed.

As manufacturer, W&H is liable for material or manufacturing defects within a warranty period of 24 months from the date of purchase.

24 months for the motor EM-11 L / EM-12 L

12 months for the supply hose VE-10 / VE-11

Accessories and consumables are excluded from the warranty

We accept no responsibility for damage caused by incorrect handling or by repairs carried out by third parties not authorized to do so by W&H!

Claims under warranty accompanied by proof of purchase, must be sent to the vendor or to an authorized W&H service partner. The provision of service under warranty extends neither the warranty period nor any other guarantee period.

24/12 months warranty

Authorized W&H service partners

Find your nearest authorized W&H service partner at <http://wh.com>
Simply go to the menu option "Service" for full details.

Or simply scan the QR code.



Manufacturer

W&H Dentalwerk Bürmoos GmbH
Ignaz-Glaser-Straße 53, 5111 Bürmoos, Austria

t +43 6274 6236-0, f +43 6274 6236-55
office@wh.com **wh.com**

Form-Nr. 50797 AEN
Rev. 003 / 20.10.2021
Subject to alterations

Instructions for use



Electric motor
EM-19 / EM-19 LC

Contents

Symbols	4
in the Instructions for use	4
on the medical device / packaging	5
1. Introduction	6
2. Safety notes	9
3. Product description	12
4. Operation	13
Assembly/Removal	14
Test run	15
5. Hygiene and maintenance	16
General notes	16
Limitations on processing	18
Initial treatment at the point of use	19
Manual cleaning	20

Manual disinfection	21
Automated cleaning and disinfection	22
Drying	23
Inspection, Maintenance and Testing	24
Packaging	25
Sterilization.....	26
Storage	28
6. Servicing	29
7. W&H Accessories and spare parts.....	31
8. Technical data	32
9. Data on electromagnetic compatibility according to IEC/EN 60601-1-2.....	34
10. Disposal	38
Explanation of warranty terms	39
Authorized W&H service partners.....	40

Symbols

in the Instructions for use



WARNING!
(risk of injury)



ATTENTION!
(to prevent
damage occurring)



General explanations,
without risk to
persons or objects

















Do not dispose of with
domestic waste

R_x_{only}

Caution!

Federal law restricts this device to sale by or on the order of a dentist, physician, veterinarian or with the descriptive designation of any other practitioner licensed by the law of the State in which the practitioner practices to use or order the use of the device.

Symbols

Symbols		on the medical device / packaging	
	CE marking with identification number of the Notified Body		Type B applied part (not suitable for intracardiac application)
	Consult Instructions for Use		UL Component Recognition Mark indicates compliance with Canadian and U.S. requirements
	Catalogue number		Medical device
	Serial number		Thermo washer disinfectable
	Date of manufacture		Sterilizable up to the stated temperature
			DataMatrix Code for product information including UDI (Unique Device Identification)
			Manufacturer
			Data structure in accordance with Health Industry Bar Code
			Temperature limitation
			Humidity limitation

1. Introduction

Customer satisfaction has absolute priority in the W&H quality policy. This medical device has been developed, manufactured and subjected to final inspection according to legal regulations, quality and industry standards.

For your safety and the safety of your patients

Prior to initial use please read the Instructions for use. These explain how to use your medical device and guarantee a smooth and efficient operation.



Observe the safety notes.

Intended use

Electrical drive for transmission instruments with ISO 3964 (DIN 13940) compatible coupling system, for use in dental surgery, implantology and maxillofacial surgery (CMF).



Misuse may damage the medical device and hence cause risks and hazards for patient, user and third parties.

Qualifications of the user

Only suitably qualified medical, technical and specialist trained staff may use the medical device.
We have based our development and design of the medical device on the physician target group.

Responsibility of the manufacturer

The manufacturer can only accept responsibility for the safety, reliability and performance of the medical device when it is used in compliance with the following directions:

- > The medical device must be used in accordance with these Instructions for use.
- > The medical device has no components that can be repaired by the user.
- > Modifications or repairs must only be undertaken by an authorized W&H service partner (see page 40).

Skilled application

The medical device is intended only for skilled application according to the intended use as well as in compliance with the valid health and safety at work regulations, the valid accident prevention regulations and in compliance with these Instructions for use.

The medical device should be prepared for use and maintained by staff who have been trained in procedures for infection control, personal safety and patient safety.

Improper use, (e.g., through poor hygiene and maintenance), non-compliance with our instructions or the use of accessories and spare parts which are not approved by W&H, invalidates all claims under warranty and any other claims.



Any serious incident that has occurred in relation to the medical device should be reported to the manufacturer and the competent authority!

2. Safety notes



- > Before using the medical device for the first time, store it at room temperature for 24 hours.
- > Check the medical device for damage and loose parts each time before using.
- > Do not operate the medical device if it is damaged.
- > Always ensure the correct operating conditions.
- > Check the parameter settings every time you restart.
- > Perform a test run each time before using.
- > Ensure that it is possible to complete the operation safely should the units or instruments fail.



- > Do not twist or kink the motor cable! Do not coil it too tightly!
- > Moisture in the medical device may cause a malfunction! (Risk of short circuit)
- > The medical device must not be disassembled.
- > The medical product is lubricated for life and therefore should not be lubricated.



The medical device is not approved for operation in potentially explosive atmospheres.

**Risks due to electromagnetic fields**

The functionality of implantable systems, such as cardiac pacemakers and implantable cardioverter defibrillator (ICD) can be affected by electric, magnetic and electromagnetic fields.

- > Find out if patient and user have implanted systems before using the medical device and consider the application.
- > Weigh the risks and benefits.
- > Keep the medical device away from implanted systems.
- > Do not place the motor on the patient's body.
- > Make appropriate emergency provisions and take immediate action on any signs of ill-health.
- > Symptoms such as raised heartbeat, irregular pulse and dizziness can be signs of a problem with a cardiac pacemaker or ICD.

**Rotational energy**

Fast deceleration of the bur can, at times, cause the selected torque to be temporarily exceeded, compared to the value set, as a result of the rotational energy stored in the drive system.

**Transmission instruments**

- > Follow the directions and safety notes in the Instructions for Use of the transmission instruments.
- > Only use transmission instruments with an ISO 3964 (DIN 13940) compatible coupling system and manufacturer approved transmission instruments.
- > Follow the directions of the manufacturer of transmission instruments with reference to transmission ratio, maximum speed and maximum torque.

**Hygiene and maintenance prior to initial use**

- > The medical device is sealed in PE film and not sterilized when delivered.
- > The PE film and the packaging are non-sterilizable.

- > Clean and disinfect the medical device.
- > Sterilize the medical device.

3. Product description

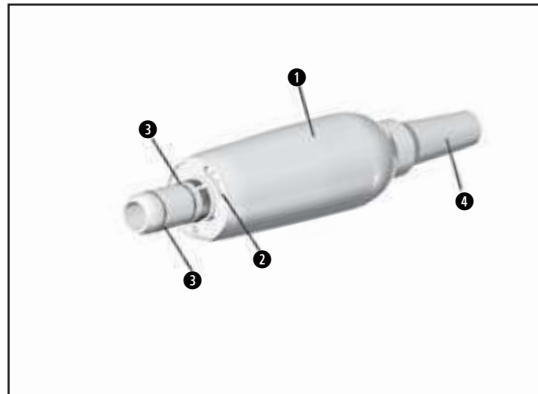



- ① Motor sheath
- ② Electrical contacts*
- ③ O-Ring
- ④ Motor cable

*only EM-19 LC

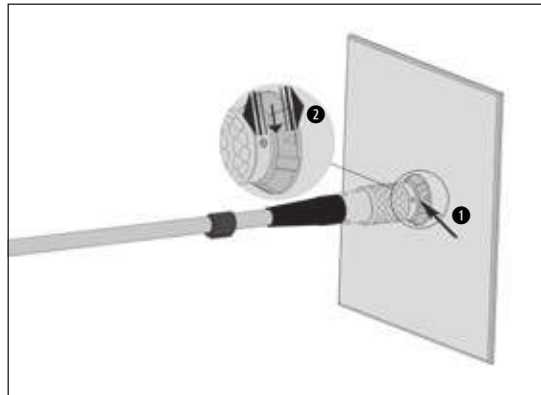
4. Operation



 Do not assemble or remove the medical device during operation!

 1 Connect motor cable.

 Pay attention to the positioning.

 2 Verify full engagement.

Operation

Assembly/Removal

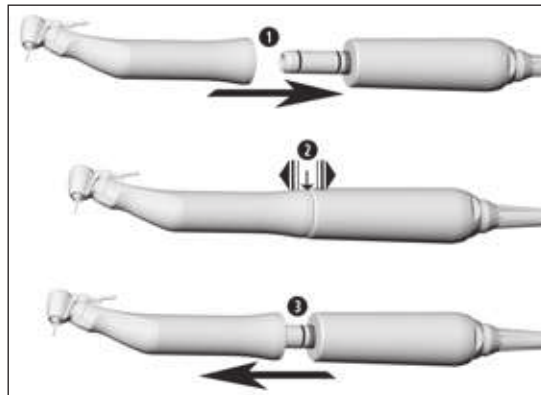

 Do not assemble or remove the medical device during operation!

1 Push the transmission instrument onto the medical device and turn it until it engages audibly.

 **2** Verify full engagement.

3 Remove the transmission instrument from the medical device by pulling in an axial direction.

Test run



Do not hold the medical device at eye level.

- > Start the medical device using the attached transmission instrument.



In the event of operating malfunctions (e.g., vibrations, unusual noise or overheating) **stop the medical device immediately** and contact an authorized W&H service partner.

5. Hygiene and maintenance

General notes



- > Follow your local and national laws, directives, standards and guidelines for cleaning, disinfection and sterilization.



- > Wear protective clothing, safety glasses, face mask and gloves.
- > Remove the transmission instrument from the medical device.



- > Use only oil-free, filtered compressed air with a maximum operating pressure of 3 bar for manual drying.



Cleaning agents and disinfectants

- > Read the notes, follow the instructions and heed the warnings provided by the manufacturers of cleaning agents and/or disinfectants.
- > Use only detergents which are intended for cleaning and/or disinfecting medical devices made of metal and plastic.
- > It is imperative to comply with the concentrations and exposure times specified by the manufacturer of the disinfectant.
- > Use disinfectants which have been tested and found effective by the Verbund für Angewandte Hygiene e.V. (VAH = Association for Applied Hygiene), the Österreichischen Gesellschaft für Hygiene, Mikrobiologie und Präventivmedizin (ÖGHMP = Austrian Society for Hygiene, Microbiology and Preventive Medicine), the Food and Drug Administration (FDA) and the U.S. Environmental Protection Agency (EPA).



The user is responsible for validating its process if the specified cleaning agents and disinfectants are not available.

Hygiene and maintenance

Limitations on processing



The product lifetime and the medical device's ability to operate correctly are mainly determined by mechanical stress during use and chemical influences due to processing.

- > Send worn or damaged medical devices and/or medical devices with material changes to an authorized W&H service partner.



Processing cycles

- > We recommend a regular service for the W&H medical device after 500 processing cycles or one year.

Hygiene and maintenance

Initial treatment at the point of use



- > Clean the medical device immediately after every treatment.
- > Wipe the entire surface of the medical device with disinfectant.



Note that the disinfectant used during pre-treatment is only for personal protection and cannot replace the disinfectant step after cleaning.



Do not place the medical device in liquid disinfectant or in an ultrasonic bath.

- > Clean the medical device under running tap water (<35°C / 95°F).
- > Rinse and brush off all internal and external surfaces.
- > Remove liquid residues using compressed air.

Hygiene and maintenance

Manual disinfection



> W&H recommends wiping down with disinfectant.



Evidence of the medical device's basic suitability for effective manual disinfection was provided by an independent test laboratory using the disinfectants "mikrozid® AF wipes" (Schülke & Mayr GmbH, Norderstedt) and "CaviWipes™" (Metrex).

Hygiene and maintenance

Automated cleaning and disinfection



W&H recommends automated cleaning and disinfection using a washer-disinfector (WD).

- > Read the notes, follow the instructions and heed the warnings provided by the manufacturers of washer-disinfectors, cleaning agents and/or disinfectants.



Evidence of the medical device's basic suitability for effective automated disinfection was provided by an independent test laboratory using the "Miele PG 8582 CD" washer disinfector (Miele & Cie. KG, Gütersloh) and the "Dr. Weigert neodisher® MediClean forte" cleaning agent (Dr. Weigert GmbH & Co. KG, Hamburg) according to ISO 15883.

- > Cleaning at 55°C (131°F) – 5 minutes
- > Disinfection at 93°C (200°F) – 5 minutes

Hygiene and maintenance

Drying



- > Ensure that the medical device is completely dry internally and externally after cleaning and disinfection.
- > Remove liquid residues using compressed air.

Inspection



- > Check the medical device after cleaning and disinfection for damage, visible residual soiling and surface changes.
- > Reprocess any medical devices that are still soiled.
- > Sterilize the medical device following cleaning and disinfection.



Pack the medical device and the accessories in sterilization packages that meet the following requirements:

- > The sterilization package must meet the applicable standards in respect of quality and use and must be suitable for the sterilization method.
- > The sterilization package must be large enough for the sterilization goods.
- > The filled sterilization package must not be under tension.



W&H recommends sterilization according to EN 13060, EN 285 or ANSI/AAMI ST55



- > Read the notes, follow the instructions and heed the warnings provided by the manufacturers of steam sterilizers.
- > The program selected must be suitable for the medical device.

Recommended sterilization procedures

- > "Dynamic-air-removal prevacuum cycle" (type B)
134°C (273°F) for at least 3 minutes, 132°C (270°F) for at least 4 minutes
- > "Gravity-displacement cycle" (type N)
121°C (250°F) for at least 30 minutes
- > Maximum sterilization temperature 135°C (275°F)



Evidence of the medical device's basic suitability for effective sterilization was provided by an independent test laboratory using the LISA 517 B17L* steam sterilizer (W&H Sterilization S.r.l., Brusaporto (BG)) and the CertoClav MultiControl MC2-S09S273** steam sterilizer (CertoClav GmbH, Traun).

“Dynamic-air-removal prevacuum cycle” (type B): 134°C (273°F) – 3 minutes*, 132°C (270°F) – 4 minutes*/**
“Gravity-displacement cycle” (type N): 121°C (250°F) – 30 minutes**

Drying times:

“Dynamic-air-removal prevacuum cycle” (type B): 132°C (270°F) – 30 minutes**
“Gravity-displacement cycle” (type N): 121°C (250°F) – 30 minutes**

* EN 13060, EN 285, ISO 17665

** ANSI/AAMI ST55, ANSI/AAMI ST79

Hygiene and maintenance

Storage



- > Store sterile goods dust-free and dry.
- > The shelf life of the sterile goods depends on the storage conditions and type of packaging.

6. Servicing



Periodic inspection

Regular periodic inspection of the function and safety of the medical device is necessary and should be carried out at least once every three years, unless shorter intervals are prescribed by law.

The periodic inspection covers the complete medical device and must only be performed by an authorized service partner.

Repairs and returns

In the event of operating malfunctions immediately contact an authorized W&H service partner.
Repairs and maintenance work must only be undertaken by an authorized W&H service partner.



> Ensure that the medical device has been completely processed before returning it.

7. W&H Accessories and spare parts



Use only original W&H accessories and spare parts or accessories approved by W&H.
Suppliers: W&H partners

04363600 Disposable irrigation tubing set 2.2 m (6 pcs)

06290600 Hose clips (5 pcs)

8. Technical data

Motor	EM-19 / EM-19 LC
Direction of rotation	forward / reverse
Speed range	200 – 40.000 rpm
Maximum torque at the motor	6,2 Ncm
Coolant volume flow at 100%:	min. 90 ml/min
Maximum power output:	80 W

Temperature information



Temperature of the medical device on the operator side: maximum 55°C (131°F)

Ambient conditions

Temperature during storage and transport:

-40°C to +70°C (-40°F to +158°F)

Humidity during storage and transport:

8% to 80% (relativ), non-condensing

Temperature during operation:

+10°C to +35°C (+50°F to +95°F)

Humidity during operation:

15% to 80% (relativ), non-condensing

Altitude:

up to 3,000 m above sea level

9. Data on electromagnetic compatibility according to IEC/EN 60601-1-2

Operating environment and EMC warning notes

This medical device is neither life-sustaining nor coupled to the patient. It is suitable for operation both in domestic healthcare and in facilities used for medical purposes except rooms/areas, in which EMC interference of high-intensity may occur.

The customer and/or the user should assure that this medical device is set up and used in an environment of the specified type and/or in accordance with the specifications of the manufacturer. This medical device uses RF energy only for its internal functions.

Therefore, its RF emissions are very low and not likely to cause any interference in nearby electronic equipment. No special precautions are necessary to maintain the basic safety and essential performance of this medical device.

Essential performance

This medical device has no critical functions and therefore does not have any essential performance features.



Portable RF communication devices

Portable RF communications equipment (including peripherals such as antenna cables and external antennas) should be used no closer than 30 cm (12 inches) to the medical device. Otherwise, degradation of the performance of this medical device could result.



W&H guarantees the compliance of the device with the EMC requirements only when used with original W&H accessories and spare parts. The use of accessories and spare parts not approved by W&H can lead to an increased emission of electromagnetic interference or to a reduced resistance against electromagnetic interference.



Use of this medical device adjacent to or stacked with other equipment should be avoided because it could result in improper operation. If such use is necessary, this medical device and the other equipment should be observed to verify that they are operating normally.



The medical device is not intended for use in the vicinity of HF surgical devices.

Results of the electromagnetic tests

Requirement	Class / Test Level*
Electromagnetic emissions	
Mains terminal disturbance voltage (Conducted Emissions) CISPR 11/EN 55011 [150 kHz – 30 MHz]	Group 1 Class B
Electromagnetic radiation disturbance (Radiated Emissions) CISPR 11/EN 55011 [30 MHz – 1000 MHz]	Group 1 Class B
Harmonic distortion IEC/EN 61000-3-2	Class A
Voltage fluctuations and flicker IEC/ EN 61000-3-3	–
Immunity to electromagnetic interference	
Electrostatic discharge (ESD) IEC/EN 61000-4-2	Contact discharge: $\pm 2 / 4 / 6 / 8$ kV Air discharge: $\pm 2 / 4 / 8 / 15$ kV
Radiated RF electromagnetic field IEC/EN 61000-4-3 [80 MHz - 2,7 GHz]	10 V/m

* There are no deviations or simplifications to IEC 60601-1-2.

Proximity fields from RF wireless communications equipment IEC/EN 60601-1-2 Table 9 IEC/EN 61000-4-3	385 MHz	27 V/m
	450 MHz	28 V/m
	710 / 745 / 780 MHz	9 V/m
	810 / 870 / 930 MHz	28 V/m
	1720 / 1845 / 1970 / 2450 MHz	28 V/m
	5240 / 5500 / 5785 MHz	9 V/m
Electrical fast transient/burst IEC/EN 61000-4-4 Electrical cables Input and output cables	±2 kV ±1 kV	
Surges IEC/EN 61000-4-5	-	
Conducted disturbances induced by RF fields IEC/EN 61000-4-6	3 V 6 V in ISM bands 6 V in amateur radio bands	
Power frequency magnetic field EN 61000-4-8	30 A/m	
Voltage dips, voltage interruptions IEC/EN 61000-4-11	-	

10. Disposal



Ensure that the parts are not contaminated on disposal.



Follow your local and national laws, directives, standards and guidelines for disposal.

- > Medical device
- > Waste electrical equipment
- > Packaging

Explanation of warranty terms

This medical device has been manufactured with great care by highly qualified specialists. A wide variety of tests and controls guarantee faultless operation. Please note that claims under warranty can only be validated when all the directions in the Instructions for use have been followed.

As manufacturer, W&H is liable for material or manufacturing defects within a warranty period of 24 months from the date of purchase. Accessories and consumables are not covered by the warranty.

We accept no responsibility for damage caused by incorrect handling or by repairs carried out by third parties not authorized to do so by W&H!

Claims under warranty accompanied by proof of purchase, must be sent to the vendor or to an authorized W&H service partner. The provision of service under warranty extends neither the warranty period nor any other guarantee period.

24 months warranty

Authorized W&H service partners

Find your nearest authorized W&H service partner at <http://wh.com>
Simply go to the menu option "Service" for full details.

Or simply scan the QR code.



Manufacturer

W&H Dentalwerk Bürmoos GmbH
Ignaz-Glaser-Straße 53, 5111 Bürmoos, Austria

t + 43 6274 6236-0, f + 43 6274 6236-55
office@wh.com wh.com

Form-Nr. 50983 AEN
Rev. 001 / 18.10.2021
Subject to alterations

Instructions for use



CE
0297



proxeo^{ULTRA}

Handpiece
PB-5 L, PB-5 L S, PB-5 L Q

Contents

Symbols	4
in the Instructions for use	4
on the medical device	5
packaging	6
1. Introduction	7
2. Safety notes	10
3. Product description	15
4. Operation	16
Assembly/Removal	16
Changing the tip	17
Test run	20
5. Hygiene and maintenance	21
General notes	21
Limitations on processing.....	23

Initial treatment at the point of use.....	24
Manual cleaning.....	25
Manual disinfection	29
Automated cleaning and disinfection.....	30
Drying	31
Inspection, Maintenance and Testing.....	32
Packaging.....	34
Sterilization	35
Storage.....	38
6. Exchanging the supply hose O-rings.....	39
7. Servicing.....	40
8. W&H Accessories and spare parts.....	41
9. Technical data.....	42
10. Disposal.....	44
Explanation of warranty terms.....	45
Authorized W&H service partners	47

Symbols

in the Instructions for use



WARNING!
(risk of injury)



ATTENTION!
(to prevent
damage occurring)



General explanations,
without risk to
persons or objects















Do not dispose of
with domestic waste



Type B applied part
(not suitable for
intracardiac application)

Symbols

on the medical device

	CE marking with identification number of the Notified Body		DataMatrix Code for product information including UDI (Unique Device Identification)		Data structure in accordance with Health Industry Bar Code
	Catalogue number		Thermo washer disinfectable	Thread system:  Q-Link  W&H  Satelec	
	Serial number		Sterilizable up to the stated temperature		
	Date of manufacture		Suitable for people with pacemakers or implanted defibrillators		

Symbols

packaging



CE marking
with identification number
of the Notified Body



DataMatrix Code
for product information
including UDI (Unique
Device Identification)



Data structure in
accordance with
Health Industry Bar Code



Caution! According to Federal law, this medical device may only be sold by or on the order of a dentist, physician or any other medical practitioner licensed by the law of the State in which he or she practices and intends to use or order the use of this medical device.

1. Introduction

Customer satisfaction has absolute priority in the W&H quality policy. This medical device has been developed, manufactured and subjected to final inspection according to legal regulations, quality and industry standards.

For your safety and the safety of your patients

Prior to initial use please read the Instructions for use. These explain how to use your medical device and guarantee a smooth and efficient operation.



Observe the safety notes.

Intended use

Drive unit with a piezoceramic oscillating system, which moves the tip in a linear oscillation. The drive unit is used for the removal of supragingival calculus and subgingival concretions and for endodontics application and preparation of tooth enamel.



Misuse may damage the medical device and hence cause risks and hazards for patient, user and third parties.

Qualifications of the user

We have based our development and design of the medical device on the dentists, dental hygienists, dental employees (prophylaxis) and dental assistants target group.

**Production according to EU Directive**

The medical device meets the requirements of Directive 93/42/EEC.

Responsibility of the manufacturer

The manufacturer can only accept responsibility for the safety, reliability and performance of the medical device when it is used in compliance with the following directions:

- > The medical device must be used in accordance with these Instructions for use.
- > The medical device has no components that can be repaired by the user.
- > Modifications or repairs must only be undertaken by an authorized W&H service partner (see page 47).
- > Unauthorized opening of the medical device invalidates all claims under warranty and any other claims.

Skilled application

The medical device is intended only for skilled application according to the intended use as well as in compliance with the valid health and safety at work regulations, the valid accident prevention regulations and in compliance with these Instructions for use.

The medical device should be prepared for use and maintained by staff who have been trained in procedures for infection control, personal safety and patient safety.

Improper use, unauthorized assembly, modification or repair to the medical device, non-compliance with our instructions or the use of accessories and spare parts which are not approved by W&H, invalidates all claims under warranty and any other claims.

2. Safety notes



- > Before using the medical device for the first time, store it at room temperature for 24 hours.
- > Always ensure the correct operating conditions and cooling function.
- > Always ensure that sufficient and adequate cooling is delivered and ensure adequate suction (except for tips where no coolant is used).
- > In case of coolant supply failure, the medical device must be stopped immediately (maximum operating time without coolant is 30 seconds). The exception are applications where no coolant is used (e.g. endodontics). Maximum operating time without coolant is 2 minutes.
- > Check the medical device for damage and loose parts each time before using (e.g., tip, handpiece cap).
- > Do not operate the medical device if it is damaged.
- > Perform a test run each time before using.
- > Do not look directly into the optic outlet.
- > Run the rinse function for the dental unit once per day.
- > Replace damaged or leaking O-rings immediately.
- > Do not twist, kink or squeeze the supply hose (risk of damage).



Tips

- > Only use tips that have been approved by W&H and the associated tip changers or spanners.
- > An overview of the correct power settings is included with every tip.
- > With periodontal tips, the medical device is suitable for the removal of concretions in the subgingival region, but not for applications which demand sterile conditions. Choose the lower performance range when carrying out periodontal treatments on hypersensitive patients in order to guarantee optimum pain-free treatment.
- > Ensure that the original shape of the tips is not affected (e.g. by being dropped).
- > The tips must not be bent back into shape or resharpened.
- > Locate and secure the tip only with the medical device switched off.
- > Never touch the tips when vibrating.
- > Insert the tip changer onto the inserted tip of the stationary medical device after every treatment (protection against injury and infection, tip protection). Tips that are changed using a spanner must be removed from the medical device immediately after treatment.
- > Do not touch into the tip changer (with tip inserted).
- > Check for the effect of wear on the tips using the accompanying tip card.
- > Change tips if there are visible signs of wear.



Approved coolants and rinsing liquids

- > Physiological saline solution (NaCl, 0.9%)
- > Hydrogen peroxide (H_2O_2 , 1–3%)
- > Liquids with the active substance chlorhexidine (CHX, 0.2%)
- > Tap water



The medical device is tailored to the W&H supply hose and the W&H control electronics and must therefore only be used with W&H products. Using other components could lead to deviating parameters or even the destruction of the system.



Risks due to electromagnetic fields

This medical device complies with the reference values defined in EN 50527-2-1/2016 for active implantable medical devices (AIMD) and cardiac pacemakers.



The medical device is not approved for operation in potentially explosive atmospheres.

Hygiene and maintenance prior to initial use



- > The medical device is not sterilized when delivered.
- > The packaging is non-sterilizable.

- > Clean and disinfect the medical device, the tips and the tip changer.
- > Sterilize the medical device, the tips and the tip changer.

3. Product description

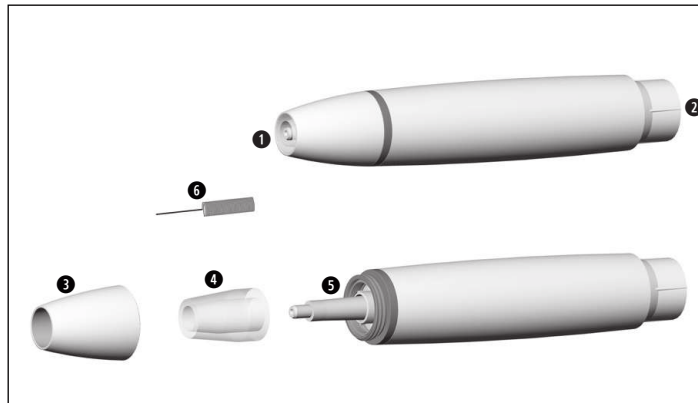

- ① Thread
- ② Connection for supply hose
- ③ Handpiece cap
- ④ Optical fibre
- ⑤ Optic outlet
- ⑥ Nozzle cleaner

4. Operation

Assembly/Removal

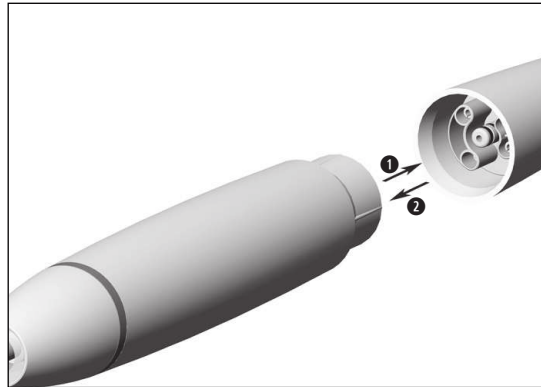

❶ Push the medical device onto the supply hose.

👉 Note the positioning.

❷ Remove the medical device.

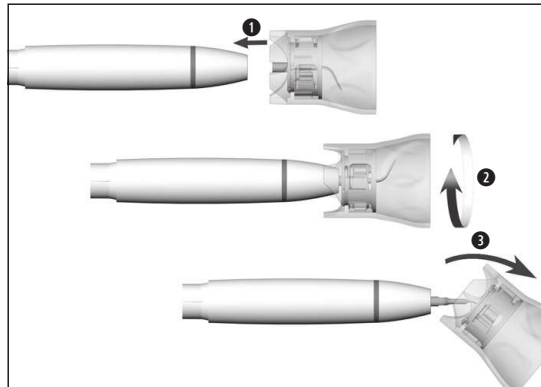

Insert tip with tip changer



Ensure the matching thread system
[at the handpiece, tip changer, tip]!

- ❶ Position the tip on the thread of the medical device.
- ❷ Turn the tip changer until it audibly engages.
- ❸ Withdraw the tip changer.



Verify full engagement.



Press the tip with about 1 N [= 100 g] pressure onto a firm object to test the loading capacity of the tip.

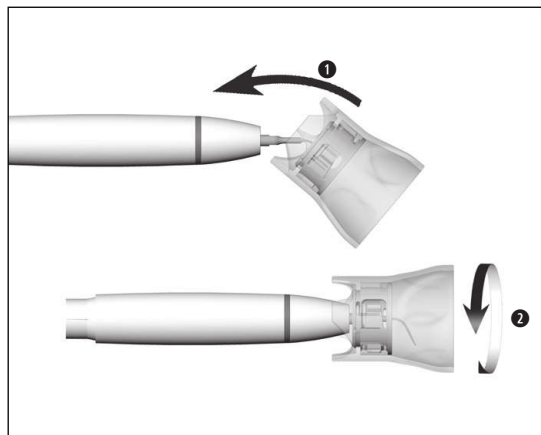

Remove tip with tip changer

- 1 Place the tip changer onto the tip.
- 2 Unscrew the tip with the tip changer.



Leave the tip in the tip changer until the hygienic maintenance process!

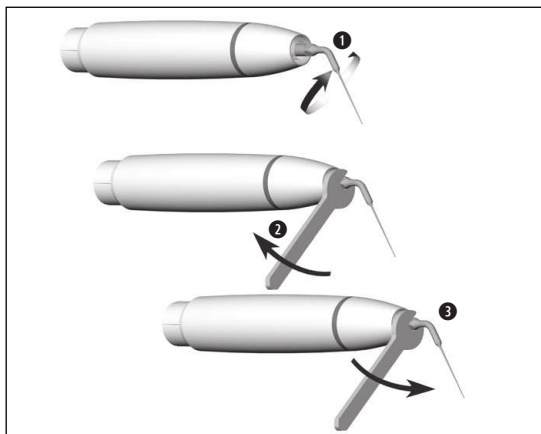

Insert/remove tip with spanner

- 1 Position the tip on the thread of the medical device.
- 2 Screw the tip down.



Verify full engagement.

- 3 Unscrew the tip.

Test run



Do not hold the medical device at eye level!

- > Attach the medical device to the supply hose.
- > Insert the tip.
- > Put the medical device into operation.



In the event of operating malfunctions (e.g. vibrations, unusual noise, overheating, coolant supply failure or leakage) **stop the medical device immediately** and contact an authorized W&H service partner.

5. Hygiene and maintenance

General notes



Follow your local and national laws, directives, standards and guidelines for cleaning, disinfection and sterilization.



> Wear protective clothing, safety glasses, face mask and gloves.



> Use only oil-free, filtered compressed air with a maximum operating pressure of 3 bar for manual drying.

Cleaning agents and disinfectants



- > Read the notes, follow the instructions and heed the warnings provided by the manufacturers of cleaning agents and/or disinfectants.
- > Use only detergents which are intended for cleaning and/or disinfecting medical devices made of metal and plastic.
- > It is imperative to comply with the concentrations and exposure times specified by the manufacturer of the disinfectant.
- > Use disinfectants which have been tested and found effective by the Verbund für Angewandte Hygiene e.V. (VAH = Association for Applied Hygiene), the Österreichischen Gesellschaft für Hygiene, Mikrobiologie und Präventivmedizin (ÖGHMP = Austrian Society for Hygiene, Microbiology and Preventive Medicine), the Food and Drug Administration (FDA) and the U.S. Environmental Protection Agency (EPA).



The user is responsible for validating its process if the specified cleaning agents and disinfectants are not available.

Hygiene and maintenance

Limitations on processing



The product lifetime and the medical device's ability to operate correctly are mainly determined by mechanical stress during use and chemical influences due to processing.

- > Send worn or damaged medical devices and/or medical devices with material changes to an authorized W&H service partner.

Processing cycles



- > We recommend a regular service for the W&H medical device after 500 processing cycles or one year.
- > We recommend to replace the tip changer after 250 processing cycles.
- > Check signs of wear on the tips (see tip card).

Hygiene and maintenance

Initial treatment at the point of use



Clean the medical device immediately after every treatment, to flush out liquid (e.g., blood, saliva etc.) and to prevent settling on the internal parts.

- > Operate the medical device for at least 10 seconds at idle speed.
- > Ensure that all coolant outlets are rinsed out.



> Wipe the entire surface of the medical device, the tip and the tip changer with disinfectant.

- > Remove the tip.
- > Remove the medical device.



Note that the disinfectant used during pre-treatment is only for personal protection and cannot replace the disinfectant step after cleaning.

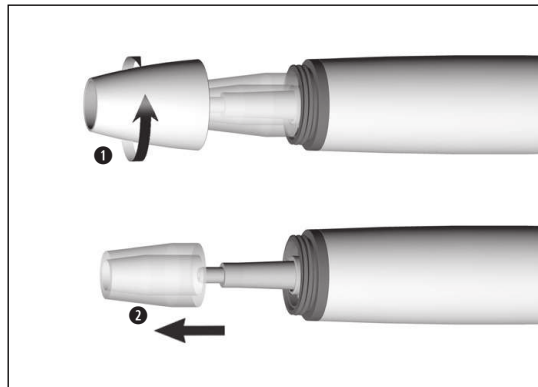

Disassembling the medical device

- 1 Unscrew the handpiece cap.
- 2 Remove the optical fibre.



Do not place the medical device and the tip changer in liquid disinfectant or in an ultrasonic bath.



Clean and disinfect diamond coated tips in an ultrasonic bath.



Evidence of the tips basic suitability for effective manual cleaning and disinfection was provided by an independent test laboratory using the »Bandelin Type RK 100 CC« ultrasonic bath and the cleaning agent and disinfectant »StammopurDR8 (DR H Stamm, Berlin)«.

- > Clean the medical device under running tap water (< 35°C/< 95°F).
- > Rinse and brush off all internal and external surfaces.
- > Remove liquid residues using compressed air.

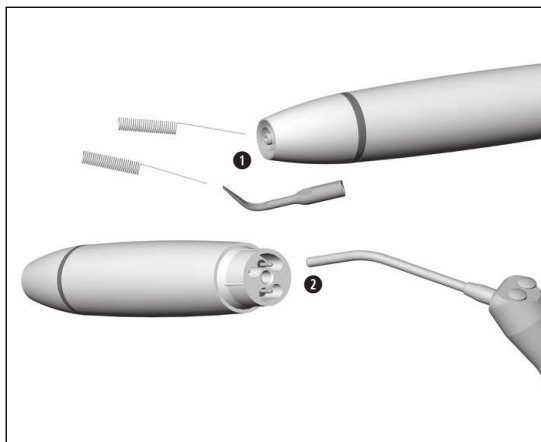

Cleaning the spray nozzles

- 1 Clean coolant outlets carefully with the nozzle cleaner to remove dirt and deposits.

 The nozzle cleaner can be cleaned in an ultrasonic bath and/or in the washerdisinfector.

Cleaning the coolant tube

- 2 Blow through the coolant tube using compressed air.

 In the case of clogged up coolant outlets or coolant tubes contact an authorized W&H service partner.

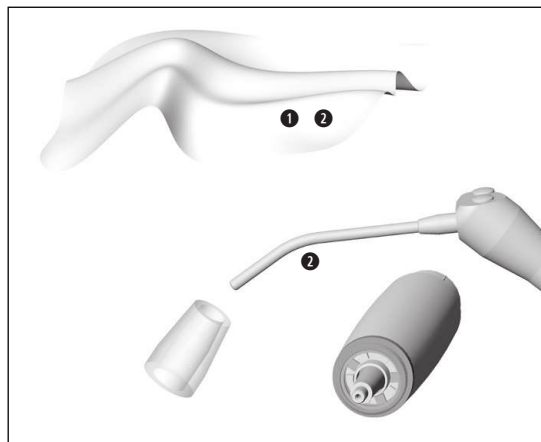

28

Cleaning the optic outlet and the optical fibre



Avoid scratching the optic outlet and the optical fibre!

- ① Wash the optic outlet and the optical fibre with cleaning fluid and a soft cloth.
- ② Blow the optic outlet and the optical fibre dry using compressed air or dry it carefully with a soft cloth.



- > Carry out a visual inspection after each cleaning process.
- > Do not use the medical device if the optic outlet or the optical fibre is damaged and contact an authorized W&H service partner.

Hygiene and maintenance

Manual disinfection



> W&H recommends wiping down with disinfectant.



Evidence of the medical device's, the tips' and the tip changer's basic suitability for effective manual disinfection was provided by an independent test laboratory using the »mikrozid® AF wipes« disinfectant [Schülke & Mayr GmbH, Norderstedt].

Hygiene and maintenance

Automated cleaning and disinfection



W&H recommends automated cleaning and disinfection using a washer-disinfector (WD).

- > Read the notes, follow the instructions and heed the warnings provided by the manufacturers of washer-disinfectors, cleaning agents and/or disinfectants.



Evidence of the basic suitability of the medical device, the tip and the tip changer for effective automated disinfection was provided by an independent test laboratory using the »Miele PG 8582 CD« washer-disinfector (Miele & Cie. KG, Gütersloh) and the »Dr. Weigert neodisher® MediClean forte« cleaning agent (Dr. Weigert GmbH & Co. KG, Hamburg) according to ISO 15883.

- > Cleaning at 55°C (131°F) – 5 minutes
- > Disinfection at 93°C (200°F) – 5 minutes

Mechanical cleaning and disinfection of the tips



Use the Miele A 814 adapter.

Hygiene and maintenance

Drying



- > Ensure that the medical device, the tip and the tip changer are completely dry internally and externally after cleaning and disinfection.
- > Remove liquid residues using compressed air.

Inspection



- > Check the medical device, the tip and the tip changer after cleaning and disinfection for damage, visible residual soiling and surface changes.
- > Reprocess any medical devices, the tip and the tip changer that are still soiled.

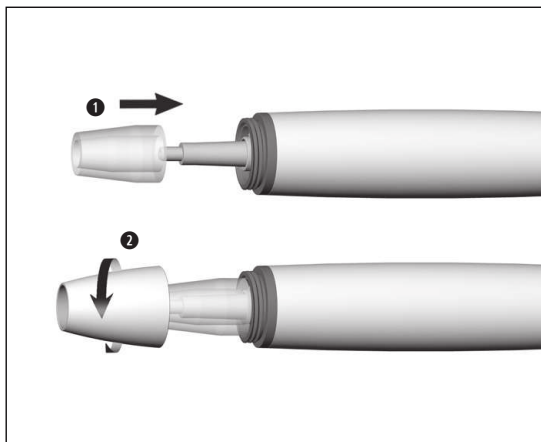

Reassembling the medical device

 Reassemble the medical device following cleaning and disinfection.

- 1 Fit optic fibre onto medical device.
- 2 Screw on the handpiece cap.

 Sterilize the medical device, the tip and the tip changer following cleaning and disinfection.



Pack the medical device, the tip and the tip changer in sterilization packages that meet the following requirements:

- > The sterilization package must meet the applicable standards in respect of quality and use and must be suitable for the sterilization method.
- > The sterilization package must be large enough for the sterilization goods.
- > The filled sterilization package must not be under tension.



W&H recommends sterilization according to EN 13060, EN 285 or ANSI/AAMI ST79.



- > Read the notes, follow the instructions and heed the warnings provided by the manufacturers of steam sterilizers.
- > The program selected must be suitable for the medical device.



- > Only sterilize the tip in the tip changer. This does not include tips which are replaced using the spanner.

Recommended sterilization cycles

- > Steam sterilization (type B, S, N)
- > Sterilization time at least 3 minutes at 134°C (273°F), 4 minutes at 132°C (270°F), 30 minutes at 121°C (250°F)
- > Maximum sterilization temperature 135°C (275°F)



Evidence of the basic suitability of the medical device, the tip and the tip changer for effective sterilization was provided by an independent test laboratory using the LISA 517 B17L steam sterilizer (W&H Sterilization S.r.l., Brusaporto [BG]), the Systec VE-150 steam sterilizer (Systec) and the CertoClav MultiControl MC2-S09S273 steam sterilizer (CertoClav GmbH, Traun).

“Dynamic-air-removal prevacuum cycle” (type B): temperature 134°C (273°F) – 3 minutes*
temperature 132°C (270°F) – 4 minutes*/**
“Steam-flush pressure-pulse cycle” (type S): temperature 134°C (273°F) – 3 minutes*
“Gravity-displacement cycle” (type N): temperature 121°C (250°F) – 30 minutes**

* EN 13060, EN 285, ISO 17665

** ANSI/AAMI ST55, ANSI/AAMI ST79

Before starting operation again



- > Wait until the medical device is completely dry.
- > Moisture in the medical device can lead to a malfunction! (Risk of short circuit)
- > Wait until the tip, the tip changer and the spanner have completely cooled down. (Risk of burning)

Hygiene and maintenance

Storage



- > Store sterile goods dust-free and dry.
- > The shelf life of the sterile goods depends on the storage conditions and type of packaging.

6. Exchanging the supply hose O-rings



- 1 Remove O-rings.
- 2 Slide on the new O-rings with a pair of tweezers.

 Always change all O-rings to ensure tightness.

7. Servicing

Repairs and returns

In the event of operating malfunctions immediately contact an authorized W&H service partner.
Repairs and maintenance work must only be undertaken by an authorized W&H service partner.



> Ensure that the medical device has been completely processed before returning it.

8. W&H Accessories and spare parts



Use only original W&H accessories and spare parts or accessories approved by W&H.
Suppliers: W&H partners

- 08025210 Handpiece cap and 3 optical fibres
- 00636901 Nozzle cleaner
- 02060203 O-ring for hose coupling (1 pc)

9. Technical data

		PB-5 L, PB-5 L S, PB-5 L O
Max. power output to the handpiece with load (ultrasonic)	(W)	10
Frequency (ultrasonic)	(kHz)	22–35
Minimum coolant supply volume	(ml/min)	0*/20
Maximum coolant supply volume	(ml/min)	50
Water pressure	(bar)	1–6
Max. oscillating amplitude (Tip 1U)	(mm)	0.2

* for tips where no coolant is used

Classification according to § 6 of the General Specifications for the Safety of Medical Electrical Equipment according to IEC 60601-1/ANSI/AAMI ES 60601-1



Type B applied part (not suitable for intracardiac application)

Temperature information

Temperature of the medical device at the operator side:	maximum 71°C (159.8°F)
Temperature of the medical device at the patient side (front area of the medical device):	maximum 50°C (122°F)
Temperature of the medical device at the patient side (optical fibre):	maximum 48°C (118.4°F)
Temperature of the working part (tip):	maximum 41°C (105.8°F)

Ambient conditions

Temperature during storage and transport:	-40°C to +70°C (-40°F to +158°F)
Humidity during storage and transport:	8% to 80% (relative), non-condensing
Temperature during operation:	+10°C to +35°C (+50°F to +95°F)
Humidity during operation:	15% to 80% (relative), non-condensing
Pollution level:	2
Overvoltage category:	II
Altitude:	up to 3,000 m above sea level

10. Disposal



Ensure that the parts are not contaminated on disposal.



Follow your local and national laws, directives, standards and guidelines for disposal.

- > Medical device
- > Waste electrical equipment
- > Packaging

Explanation of warranty terms

This W&H medical device has been manufactured with great care by highly qualified specialists. A wide variety of tests and controls guarantees faultless operation. Please note that claims under warranty can only be validated when all the directions in the Instructions for use have been followed.

As the manufacturer, W&H is liable for material or manufacturing defects within a warranty period of 24 months from the date of purchase. Accessories and consumables (tips, tip changer, nozzle cleaner) are excluded from the warranty.

We accept no responsibility for damage caused by incorrect handling or by repairs carried out by third parties not authorized to do so by W&H!

Claims under warranty accompanied by proof of purchase must be sent to the vendor or to an authorized W&H service partner. The provision of service under warranty extends neither the warranty period nor any other guarantee period.

24 months warranty

Authorized W&H service partners

Find your nearest authorized W&H service partner at <http://wh.com>
Simply go to the menu option »Service« for full details.

Or simply scan the QR code.



Manufacturer

W&H Dentalwerk Bürmoos GmbH
Ignaz-Glaser-Straße 53, 5111 Bürmoos, **Austria**

t +43 6274 6236-0, f +43 6274 6236-55
office@wh.com **wh.com**

Form-Nr. 51005 AEN
Rev. 002 / 03.02.2020
Subject to alterations

Instructions for Use



CE
0297

Foot control
S-NW, S-N2, S-N1

Contents

Symbols	3
1. Introduction	8
2. Electromagnetic compatibility (EMC)	10
3. Scope of delivery	11
4. Safety notes	12
5. Attaching - detaching the locator	15
6. Foot control S-NW	16
Inserting and replacing batteries	16
Replacing the O-ring.....	17
Connecting and disconnecting the CAN dongle	18
Description of CAN dongle	19
Connecting and disconnecting the SPI dongle.....	20
Description of SPI dongle.....	21
Assistance with pairing problems	22
7. Foot control S-N2 / S-N1	23
8. Hygiene and maintenance	24
9. Servicing	25
10. W&H accessories and spare parts	26
11. Technical data	27
12. Disposal	29
Explanation of warranty terms	30
Authorized W&H service partners	31
Manufacturer's declaration	32

Symbols

in the Instructions for Use



WARNING!
(if persons could be injured)



ATTENTION!
(if property could be damaged)



General explanations,
without risk to persons or property



Foot control

Symbols

on the foot control S-NW



CE marking
with identification number
of the Notified Body



Non-ionizing electromagnetic
radiation



Catalogue number



Do not dispose of with
domestic waste



Battery compartment closed



Serial number



DataMatrix code
for product information
including UDI (Unique Device
Identification)



Battery compartment open



Date of manufacture



Manufacturer



Category AP equipment



Medical Device



UL Component Recognition
Mark indicates compliance
with Canadian and U.S.
requirements

Symbols

radio symbols on the foot control S-NW



007 - AB0103

GITEKI (MIC) – Japan



01237-16-03402

ANATEL – Brazil

Contains FCC ID: QOQBLE113
Contains IC: 5123A-BGTBLE113

FCC / IC – USA / Canada

Complies with
IMDA Standards
DA103787

IMDA – Singapur*

*Symbol only in IFU



NCC – Taiwan

S-NW: CCAH19LP2780T2
CAN dongle: CCAH19LP2790T5
SPI dongle: CCAH19LP2800T8



RCM – Australian / New Zealand



IC – South Korea

KCC-CRM-BGT-BLE113

This device complies with part 15 of the FCC Rules. Operation is subject to the following two conditions: (1) this device may not cause harmful interference, and (2) this device must accept any interference received, including interference that may cause undesired operation.

This equipment has been tested and found to comply with the limits for a Class B digital device, pursuant to part 15 of the FCC Rules. These limits are designed to provide reasonable protection against harmful interference in a residential installation. This equipment generates, uses and can radiate radio frequency energy and, if not installed and used in accordance with the instructions, may cause harmful interference to radio communications. However, there is no guarantee that interference will not occur in a particular installation. If this equipment does cause harmful interference to radio or television reception, which can be determined by turning the equipment off and on, the user is encouraged to try to correct the interference by one or more of the following measures:

- > Reorient or relocate the receiving antenna.
- > Increase the separation between the equipment and receiver.
- > Connect the equipment into an outlet on a circuit different from that to which the receiver is connected.
- > Consult the dealer or an experienced radio/TV technician for help.

Symbols

on the foot control S-N2 / S-N1



CE marking
with identification number
of the Notified Body



Catalogue number



Manufacturer



Do not dispose of with
domestic waste



Serial number



Medical Device



DataMatrix code
for product information
including UDI (Unique Device
Identification)



Date of manufacture



Category AP equipment





UL Component Recognition
Mark indicates compliance
with Canadian and U.S.
requirements

Symbols

on the packaging

 CE marking
with identification number
of the Notified Body

 This way up

 Fragile, handle with care

 Keep dry

 “Der Grüne Punkt” (The Green Dot)
trademark of Duales System
Deutschland GmbH

 Trademark of RESY OfW GmbH
for identification of recyclable
transport and outer packaging
of paper and cardboard



DataMatrix code
for product information including UDI
(Unique Device Identification)



Data structure in accordance with
Health Industry Bar Code

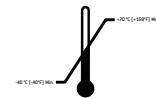

Temperature limitation



Humidity limitation



Caution! According to Federal law restricts this
device to sale by or on the order of a physician,
dentist, veterinarian or with the descriptive
designation of any other practitioner licensed
by the law of the State in which the practitioner
practices to use or order the use of the device.

1. Introduction



For your safety and the safety of your patients

These Instructions for use explain how to use your medical device. However, we must also warn against possible hazardous situations. Your safety, the safety of your team and, of course, the safety of your patients, are of paramount importance to us.



Observe the safety notes.

Intended use

Foot control for operation of medical electrical equipment.



Misuse may damage the foot control and hence cause risks and hazards for patients, users and third parties.

Qualifications of the user

We have based our development and design of the foot control for the physician, dental hygienists, dental employees (prophylaxis) and dental assistants target group.

Introduction

Hereby, W&H declares that the medical product is in compliance with Directive 2014/53/EU (RED).
The full text of the EU declaration of conformity is available at the following internet address <https://wh.com>

Responsibility of the manufacturer

The manufacturer can only accept responsibility for the safety, reliability and performance of the foot control when it is used in compliance with the following directions:

- > The foot control must be used in accordance with these Instructions for Use and with the Instructions for Use of the drive unit.
- > The foot control has no components that can be repaired by the user.
- > Modifications or repairs must only be undertaken by an authorized W&H service partner (see page 31).
- > Unauthorized opening of the foot control invalidates all claims under warranty and any other claims.

The respective foot control may only be used with the control unit listed in the scope of delivery.

Improper use, unauthorized assembly, modification or repair to the medical device, non-compliance with our instructions or the use of accessories and spare parts which are not approved by W&H, invalidates all claims under warranty and any other claims.



Any serious incident that has occurred in relation to the medical device should be reported to the manufacturer and the competent authority!

2. Electromagnetic compatibility (EMC)



Medical electrical equipment is subject to particular precautions in regard to EMC and must be installed and put into operation in accordance with the EMC notes included.

W&H guarantees the compliance of the device with the EMC requirements only when used with original W&H accessories and spare parts. The use of accessories and spare parts not approved by W&H can lead to an increased emission of electromagnetic interference or to a reduced resistance against electromagnetic interference.

HF communication equipment

Portable HF communications equipment (including peripherals such as antenna cables and external antennas) should be used no closer than 30 cm (12 inches) to the medical device. Otherwise, degradation of the performance of this medical device could result.

The medical device may be interfered by other equipment, even if these other devices comply with CISPR (International special committee on radio interference) emission requirements.

Use of this medical device adjacent to or stacked with other equipment should be avoided because it could result in improper operation. If such use is necessary, this medical device and the other equipment should be observed to verify that they are operating normally.

The medical device is not intended for use in the vicinity of HF surgical devices.

3. Scope of delivery

Foot control	Incl. dongle	Compatible with control unit*
S-NW, REF 30264000 S-NW, REF 30264003	REF 07759700	SI-1010/SI-1015/SI-1023, M-UK1010/ M-UK1015/M-UK1023, SA-430 M/SA-435 M Built-In Solution (to be agreed with the system assembler)
S-NW, REF 30264001	REF 07795800	SA-320, SA-310, SI-915/SI-923 (REF 16929000/16929001)
S-N2, REF 30285000 S-N2, REF 30285002		SI-1010/SI-1015/SI-1023, SI-915/SI-923 (REF 30286xxx, 30287xxx) M-UK1010/M-UK1015/M-UK1023, SA-430 M/SA-435 M Built-In Solution (to be agreed with the system assembler)
S-N1, REF 05046200		SI-915/SI-923 (REF 009001xx)
S-N1, REF 06202400		SA-310 SI-915/SI-923 (REF 16929000/16929001)
S-N1, REF 07004400		SA-320
S-N1, REF 06382200		PA-123, PA-115
Locator, REF 04653500		For all listed foot controls

Foot control S-NW
3 disposable batteries AA / Mignon / LR6 / 1.5V

* Not included

4. Safety notes

General



- > Before using the foot control for the first time, store it at room temperature for 24 hours.
- > Check the foot control for damage and loose parts each time before using.
- > Do not operate the foot control if it is damaged.
- > Replace the foot control as soon as the resistance is noticeably reduced.
- > Never touch the patient and the electrical contacts on the medical device simultaneously.

- > The ESD spring contact on the bottom of the foot control must be in contact with the ground during operation.



ESD is the abbreviation for “electrostatic discharge”.



The foot control is approved for use in explosive areas (AP).



Risks due to electromagnetic fields

The functionality of implantable systems, such as cardiac pacemakers and implantable cardioverter defibrillator (ICD) can be affected by electric, magnetic and electromagnetic fields.

- > Find out if patient or user have implanted systems before using the medical device and consider the application.
- > Weigh the risks and benefits.
- > Keep the medical device away from implanted systems.
- > Make appropriate emergency precautions and take immediate action on any signs of ill-health.
- > Symptoms such as raised heartbeat, irregular pulse and dizziness can be signs of a problem with a cardiac pacemaker or ICD.



Keep the orange/middle button pressed and switch between the control units/applications.



Disposable batteries

- > Replace the disposable batteries at the first prompt (battery icon on display or LED on dongle).
- > Replace batteries outside explosive atmospheres only.
- > Pay attention to the battery icon on the display before and after each treatment.



- > Dispose faulty or flat batteries immediately and correctly via recycling systems. Do not dispose batteries in domestic waste.



- > Use only high-quality disposable alkaline AA / Mignon / LR6 / 1.5 V batteries. Risk of explosion if the wrong type of battery is used.
 - > Do not mix new, old or different types of disposable batteries.
 - > Do not use rechargeable batteries.
 - > When inserting disposable batteries make sure that they are correctly oriented.
 - > Check the O-ring of the battery cover for damage. Replace a faulty or leaking O-ring immediately.
 - > Always keep spare batteries on hand.



- Disposable batteries may cause damage due to leakage or corrosion.
 - > Remove the disposable batteries if you are not going to use the foot control for a longer period.
 - > See the safety notes of the battery manufacturer.

5. Attaching - detaching the locator

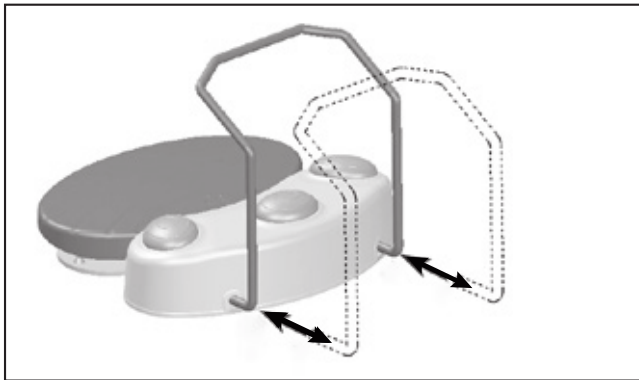

Attaching and detaching the locator

- > Push it right in until the locator reaches the stop.
- > Pull the locator out.

6. Foot control S-NW

Inserting and replacing batteries

Open battery compartment

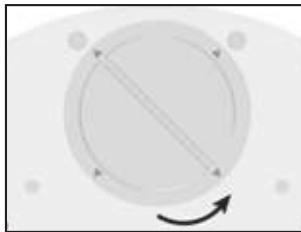

❶ Open the battery compartment.



Note the symbols!

Remove batteries



❷ Pull the red thread to remove the batteries.

Insert batteries



Reposition the red thread before inserting batteries.

❸ Insert the batteries.



Pay attention to the positioning!

Lock battery compartment

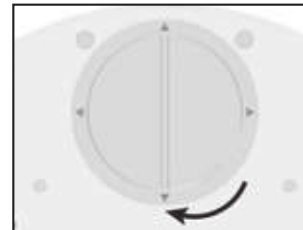

❹ Lock the battery compartment.

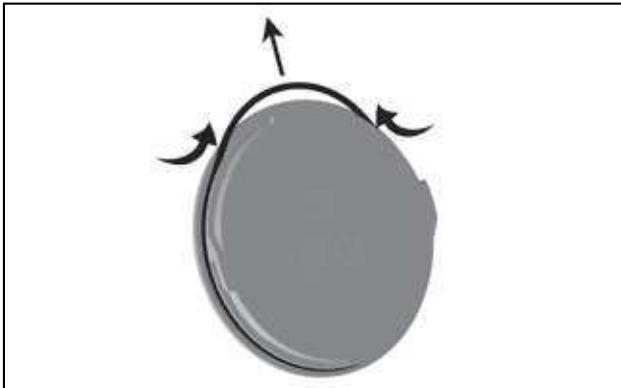

Do not use sharp tools!

- 1 Firmly squeeze the O-ring between your thumb and index finger so that it forms a loop.
- 2 Pull off the O-ring.
- 3 Push the new O-ring on in its place.

Connecting CAN dongle

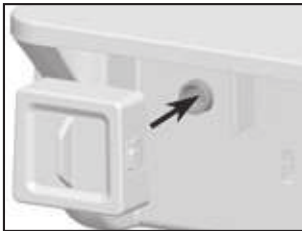

❶ Plug in the CAN dongle.



Pay attention to the positioning!

Removing CAN dongle



❷ Press the side lock and remove the CAN dongle.

Foot control S-NW

Description of CAN dongle

CAN dongle activated

-  Icon visible on display
- > CAN dongle inserted
 - > Control unit switched on
 - > Foot control actuated



Pairing

- > The foot control S-NW and the CAN dongle are paired by default.
- > If pairing is inactive, you can activate pairing on the control unit (see Instructions for Use Implantmed/system assembler) and follow the directions.
- > Press and hold the green/left and orange/middle buttons simultaneously on the S-NW foot control for at least 3 seconds.

Disable pairing

Press and hold all three buttons simultaneously on the foot control S-NW for at least three seconds.

Switching between multiple control units

Press the orange/middle button for 3 seconds.

Change application

Press the orange/middle button for 3 seconds until an acoustic signal sounds.

Connecting and disconnecting the SPI dongle



 Pay attention to the positioning!

- 1 Plug in the SPI dongle or disconnect the SPI dongle from the control unit.



- 2 Attach the SPI dongle to the irrigant support or remove the SPI dongle from the irrigant support.

Foot control S-NW

Description of SPI dongle

Green – SPI dongle activated

LED on if the SPI dongle is connected and the control unit is switched on.

Orange – battery

LED flashes if the batteries on the foot control need to be replaced.

Blue – pairing



The foot control S-NW and the SPI dongle are paired in default status.

If pairing is active: LED indicator flashes

If pairing is inactive:

- ① Press and hold the button on the SPI dongle for 4 seconds.
- ② LED indicator flashes. SPI dongle is in pairing mode for 30 seconds.
- ③ Press and hold the green and orange buttons simultaneously on the S-NW foot control.
- ④ LED flashes three times when pairing is successful.

Disable pairing

Press and hold the green, orange and yellow buttons simultaneously on the foot control S-NW for at least three seconds.

Switching between multiple control units

Press the orange/middle button for 3 seconds.

Foot control S-NW

Assistance with pairing problems

- > Check the plug-in connection of the dongle.
- > Remove metallic objects between foot control, control unit and dongle.
- > Change the position of the foot control.
- > Eliminate any sources of interference (e.g. brush motors, mobile telephones, radios, WLAN, ...).
- > Replace the pairing and repeat the pairing process.
- > Remove and replace the batteries.

If the pairing problem cannot be remedied using the steps described above, the unit will need to be inspected by an authorized W&H service partner.

7. Foot control S-N2 / S-N1

Connecting / disconnecting

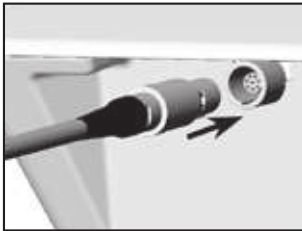

 Pay attention to the positioning!

- 1 Plug in the foot control S-N2 / S-N1 or disconnect the foot control from the control unit.

8. Hygiene and maintenance

General notes



Follow your local and national laws, directives, standards and guidelines for cleaning.



> Wear protective clothing, safety glasses, face mask and gloves.



> The foot control is sealed and may be wiped clean.

> The foot control is not approved for automated processing in a washer-disinfector and sterilization.



> The ESD spring contact on the bottom of the foot control must be cleaned regularly.

9. Servicing



Regular checks

Regular periodic inspection of the function and safety of the medical device is necessary and should be carried out at least once every three years, unless shorter intervals are prescribed by law.

The periodic inspection covers the complete medical device and must only be performed by an authorized service partner.

Repairs and returns

In the event of operating malfunctions immediately contact an authorized W&H service partner.

Repairs and maintenance work must only be undertaken by an authorized W&H service partner.



- > Always return equipment in the original packaging
- > Foot control S-NW: Remove the batteries.

10. W&H accessories and spare parts



Use only original W&H accessories and spare parts or accessories approved by W&H.

Suppliers: W&H partners (Link: <https://www.wh.com>)



07759700
CAN dongle



07795800
SPI dongle

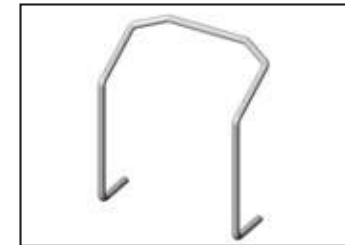

04653500
Locator for foot control

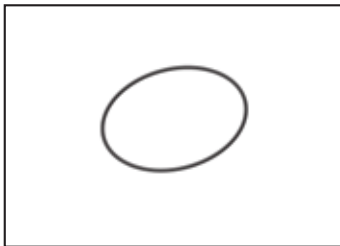

07823400
O-ring

11. Technical data

Foot control	S-NW	S-N2 / S-N1
Power supply:	3 disposable batteries AA / Mignon / LR6 / 1,5V	–
Dimensions in mm (height x width x depth):	154 x 202 x 210	156 x 207 x 206
Weight in kg:	1.2	1.3

Frequency band:	2.4 GHz ISM band (2.402 – 2.480 GHz)
Transmitting power:	Class 3:1 mW (0 dBm)
Modulation:	GFSK
Channels:	40 channels with 2 MHz spacing

Ambient conditions	
Temperature during storage and transport:	-40 °C to +70 °C (-40°F to +158°F)
Humidity during storage and transport:	8 % to 80 % (relative), non-condensing
Temperature during operation:	+10 °C to +40 °C (+50°F to +104°F)
Humidity during operation:	15 % to 80 % (relative), non-condensing

Technical data

Classification according to Paragraph 6 of the General Specifications for the Safety of Medical Electrical Device according to IEC 60601-1/ANSI/AAMI ES 60601-1



S-NW / S-N2 / S-N1 are approved for operation in potentially explosive atmospheres.



S-NW / S-N2 / S-N1 are waterproof according to IPX8, 1 m depth of immersion, 1 hour (water-tight in accordance with IEC 60529)

Pollution level: 2
Altitude: up to 3,000 m above sea level

12. Disposal



Ensure that the parts are not contaminated on disposal.



Follow your local and national, directives, standards and guidelines for disposal.

- > Medical device
- > Waste electrical equipment
- > Packaging

Explanation of warranty terms

This W&H product has been manufactured with great care by highly qualified specialists. A wide variety of tests and controls guarantees faultless operation. Please note that claims under warranty can only be validated when all the directions in the Instructions for Use have been followed.

As the manufacturer, W&H is liable for material or manufacturing defects within a warranty period of twenty-four months from the date of purchase. Accessories and consumables (batteries, O-ring, locator for foot control) are not covered by the warranty.

We accept no responsibility for damage caused by incorrect handling or by repairs carried out by third parties not authorized to do so by W&H!

Claims under warranty – accompanied by proof of purchase – must be sent to the vendor or to an authorized W&H service partner. The provision of service under warranty extends neither the warranty period nor any other guarantee period.

24 months warranty

Authorized W&H service partners

Find your nearest authorized W&H service partner at <http://wh.com>
Simply go to the menu option "Service" for full details.

Or simply scan the QR code.



Manufacturer's declaration

Immunity Test	IEC 61000-4-6 (3rd Ed.)	IEC 61000-4-6 (4th Ed.)	Compliance Level	Electromagnetic Environment Guide
Conducted RF IEC 61000-4-6	3 V _{rms} 150 kHz to 80 MHz	3 V _{rms} 150 kHz to 80 MHz & V _{rms} in ISM and amateur radio bands* between 0.15 MHz and 80 MHz	6 V _{rms}	Portable and mobile RF communication equipment should be used in close proximity to the product, including cables, than the recommended separation distance calculated from the equation applicable to the frequency of the transmitter. Recommended separation distance: d = 1,2√P d = 2,5√P
Radiated RF IEC 61000-4-3	3 V _{1m} 80 MHz to 2,5 GHz	10 V _{1m} 80 MHz to 2,7 GHz	10 V _{1m}	d = 1,2√P for 80 MHz to 800 MHz d = 2,5√P for 800 MHz to 2,5 GHz where P is the maximum output power rating of the transmitter in Watt (W) according to the transmitter manufacturer and d is the recommended separation distance in meters (m) Field strengths from fixed RF transmitters, as determined by an electromagnetic site survey [†] , should be less than the compliance level [‡] in each frequency range.  Interference may occur in the vicinity of equipment marked with the symbol described lateral.

Note 1: At 80 MHz and 800MHz, the highest frequency range applies.

Note 2: These guidelines may not apply in all situations. Electromagnetic propagation is affected by absorption and reflection from structures, objects, people and animals.

* The ISM (Industrial, Scientific and Medical) bands are between 0,15 MHz and 80 MHz and 407,55 MHz to 4,750 MHz; 13,553 MHz to 13,567 MHz; 20,967 MHz to 21,203 MHz; 40,68 MHz to 40,70 MHz. The amateur radio bands are 0,15 MHz to 80 MHz and 1,8 MHz to 2,01 MHz; 3,5 MHz to 3,7 MHz; 5,3 MHz to 5,4 MHz; 7 MHz to 7,1 MHz; 10,1 MHz to 10,15 MHz; 1,1 MHz to 1,47 MHz; 13,07 MHz to 13,17 MHz; 21,0 MHz to 21,4 MHz; 24,89 MHz to 24,99 MHz; 28,0 MHz to 29,7 MHz and 50,0 MHz to 54,0 MHz.

† Field strengths from fixed transmitters, such as base stations for radio (cellular/mobilities) telephones and land mobile radios, amateur radio, AM and FM radio broadcast and TV broadcast cannot be predicted theoretically with accuracy. To assess the electromagnetic environment due to fixed RF transmitters, an electromagnetic site survey should be considered. If the measured field strength in the location in which the product is used exceeds the applicable RF compliance level above, the product should be observed, additional measures may be necessary, such as reorienting or relocating the product.

‡ Over the frequency range 150 kHz to 80 MHz, field strengths should be less than 3 V_{1m}.

Manufacturer's declaration

Immunity level of RF fields from wireless communication devices
(Table 5, IEC 60601-1-2:2014)

Test frequency (MHz)	Band ^{a)} (MHz)	Service ^{b)}	Modulation ^{c)}	Maximum power (W)	Distance (m)	IMMUNITY TEST LEVEL (V/m)
385	380-390	TETRA 400	Pulse modulation ^{c)} 18 Hz	1.8	0.3	27
450	430-470	GMRG 450, PRG 450	FM ^{c)} ± 5 MHz deviation 1 kHz tone	2	0.3	28
710	704-727	LTE Band 13, 17	Pulse modulation ^{c)} 217 Hz	0.2	0.3	9
810		GSM 800/900, TETRA 800, DEN 800, CDMA 800, LTE Band 5	Pulse modulation ^{c)} 18 Hz	2	0.3	28
870	800-960					
890						
1720		GSM 1800, CDMA 1800, GSM 1900, DECT, LTE Band 1, 3, 4, 25, UMTS	Pulse modulation ^{c)} 217 Hz	2	0.3	28
1845	1700-1990					
1970						
2450	2400-2570	Bluetooth, WLAN, 802.11g/n, RFID 2450, LTE Band 7	Pulse modulation ^{c)} 217 Hz	2	0.3	28
5240						
5500	5100-5800	WLAN 802.11 ah	Pulse modulation ^{c)} 217 Hz	0.2	0.3	9
5785						

NOTE: If necessary to achieve the IMMUNITY TEST LEVEL, the distance between the transmitting antenna and the product may be reduced to 1 m. The 1 m test distance is permitted by IEC 61000-4-3.

^{a)} For some services, only the uplink frequencies are included.

^{b)} The carrier shall be modulated using a 50 % duty cycle square wave signal.

^{c)} As an alternative to FM modulation, 50 % pulse modulation at 10 Hz may be used because while it does not represent actual modulation, it would be worst case.

Manufacturer's declaration

Recommended Separation Distances between portable and mobile HF- communications equipment and the product (Table 6, IEC 60601-1-2:2007)

The product is intended for use in an electromagnetic environment in which radiated RF disturbances are controlled. The customer or the user of the product can help prevent electromagnetic interference by maintaining a minimum distance between portable and mobile RF communications equipment (transmitters) and the product – according on output power and frequency of the communications equipment – as recommended in the following table.

Rated maximum output power of transmitter in watts (W)	Separation distance according to the frequency of transmitter in meter (m)	
	150 MHz to 80 MHz	80 MHz to 800 MHz
	d = 1,2 ⋅ P ^{0,5}	d = 1,2 ⋅ P ^{0,5}
0,01	0,12	0,35
0,1	0,38	0,75
1	1,2	2,5
10	3,8	7,5
100	12	25

For transmitters rated at a maximum output power not listed above, the recommended separation distance d (in meters) can be estimated using the equation applicable to the frequency of the transmitter, where P is the maximum output power rating of the transmitter in watt (W) according to the transmitter manufacturer.

Note 1: At 80 MHz and 800kHz, the higher frequency range applies.

Note 2: These guidelines may not apply in all situations. Electromagnetic propagation is affected by absorption and reflection from structures, objects, people and animals.

Electromagnetic Emission (Table 1, IEC 60601-1-2:2007)

The product is suitable for use in a specific electromagnetic environment. The customer and/or the user of the product should assure that it is used in an electromagnetic environment as described below.

Emission Test	Compliance	Electromagnetic Environment Guidance
RF-emission CISPR 11	Group 1	The product can be used only for its intended function. Transients in RF emissions are very low and not likely to cause any interference in nearby electronic equipment. However, a separation distance of 30 cm shall be maintained.
RF-emission CISPR 11	Class B	The product is suitable for use in all establishments, including domestic establishments, where the density of connected public telephones is high. The product shall not be used in public buildings used for domestic purpose.
Harmonic emissions IEC 61000-3-11	Class A	
Voltage fluctuations/ Flicker emissions IEC 61000-3-17	complies	

(1) Remark: for devices with power consumption of 75 W to 1000 W only.

Manufacturer

W&H Dentalwerk Bürmoos GmbH
Ignaz-Glaser-Straße 53, 5111 Bürmoos, **Austria**

t + 43 6274 6236-0, **f** + 43 6274 6236-55
office@wh.com **wh.com**

Form-Nr. 50882 AEN
Rev. 006 / 04.06.2021
Subject to alterations



Instructions for Use



Peristaltic pump

Contents

Symbols	4
in the Instructions for Use.....	4
on the medical device.....	5
1. Introduction	6
2. Electromagnetic compatibility (EMC)	8
3. Unpacking	9
4. Scope of delivery	10
5. Safety notes	11
6. Description	13
7. Handling	14
Changing the irrigation tubing set	14
8. Hygiene and maintenance	19
9. Servicing	20
10. W&H accessories	21
11. Technical Data	22
12. Disposal	23
Explanation of warranty terms	24
Authorised W&H service partners	25

Symbols

in the Instructions for Use



WARNING!
(risk of injury)



ATTENTION!
(in cases where something could
be damaged)



ATTENTION!
(in cases where something could
be damaged)

Symbols

on the medical device

 UL Component Recognition Mark
indicates compliance with
Canadian and U.S. requirements

 REF Catalogue number

 DataMatrix Code
for product information
including UDI (Unique
Device Identification)

 CE mark

 SN Serial number

1. Introduction



For your safety and the safety of your patients

These Instructions for use explain how to use your medical device. However, we must also warn against possible hazardous situations. Your safety, the safety of your team and, of course, the safety of your patients are of paramount importance to us. The peristaltic pump is defined as medical device.



Observe the safety notes.

Intended use

The pump is a peristaltic pump for coolant supply



Misuse may damage the medical device and hence cause risks and hazards for patient, user and third parties.

Qualifications of the user

We have geared our development and design of the pump to the user.

Introduction

CE **Production according to EU Directive**
The medical device meets the requirements of Directive 93/42/EEC.

Responsibility of the manufacturer

The manufacturer can only accept responsibility for the safety, reliability and performance of the medical device when it is used in compliance with the following directions:

- > The medical device must be used in accordance with these Instructions for use.
- > The medical device has no components that can be repaired by the user. Modifications or repairs must only be undertaken by an authorised W&H service partner (page 25).
- > The electrical installation at the premises must comply with the regulations laid out in IEC 60364-7-710 (»Installation of electrical equipment in rooms used for medical purposes«) or with the regulations applicable in your country.
- > Unauthorized opening of the equipment invalidates all claims under warranty and any other claims.

Improper use, unauthorized assembly, modification or repair to the medical device, non-compliance with our instructions or the use of accessories and spare parts which are not approved by W&H, invalidates all claims under warranty and any other claims.

2. Electromagnetic compatibility (EMC)



Medical electrical equipment is subject to particular precautions in regard to EMC and must be installed and put into operation in accordance with the EMC notes included.

W&H guarantees the compliance of the device with the EMC requirements only when used with original W&H accessories and spare parts. The use of accessories and spare parts not approved by W&H can lead to an increased emission of electromagnetic interference or to a reduced resistance against electromagnetic interference



You can find the current EMC manufacturer's declaration on our website at <http://wh.com> or request a copy directly from the manufacturer.



HF communication equipment

Do not use any portable and mobile HF communication equipment (such as e.g., mobile telephones) during operation. These may affect medical electrical equipment.

3. Unpacking

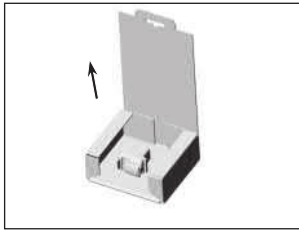

❶ Open the packaging.

W&H packaging is environmentally friendly and can be disposed of by industrial recycling companies.

However, we recommend that you keep the original packaging.

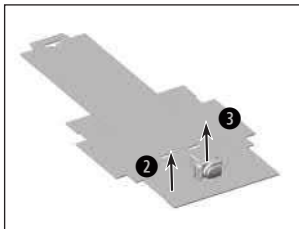

❷ Remove the foil.

❸ Remove the peristaltic pump with cable.

4. Scope of delivery

REF 30358000 Peristaltic pump

REF 774010 Screw kit M3

5. Safety notes



- > Before using the medical device for the first time, store it at room temperature for 24 hours.
- > Always ensure the correct operating conditions and cooling function.
- > Check the medical device for damage and loose parts each time before using.
- > Do not operate the medical device if it is damaged.
- > Check the parameter settings every time the device is restarted.
- > Perform a test run each time before using.
- > In the event of operating malfunctions (e.g., vibrations, unusual noise, overheating) stop the medical device immediately and contact an authorized W&H service partner.
- > The responsibility for the use and timely shutdown of the system lies with the user.
- > Ensure that it is possible to complete the operation safely should the medical device or instruments fail.
- > Operation is only permitted on dental units that conform to the IEC 60601-1 (EN 60601-1) und IEC 60601-1-2 (EN 60601-1-2) standards.



The medical device is not approved for operation in potentially explosive atmospheres.



Do not twist or kink the cable! Do not coil it too tightly!



The medical device is classed as »conventional equipment« (closed equipment without protection against the ingress of water).

Safety notes



System failure

A total system failure does not constitute a critical fault.



Risks due to electromagnetic fields

The functionality of implantable systems, such as cardiac pacemakers and implantable cardioverter defibrillator (ICD) can be affected by electric, magnetic and electromagnetic fields.

- > Find out if patient and user have implanted systems before using the medical device and consider the application.
- > Weigh the risks and benefits.
- > Keep the medical device away from implanted systems.
- > Make appropriate emergency provisions and take immediate action on any signs of ill-health.
- > Symptoms such as raised heartbeat, irregular pulse and dizziness can be signs of a problem with a cardiac pacemaker or ICD.

6. Description



Peristaltic pump at the dental unit

7. Handling

Changing the irrigation tubing set

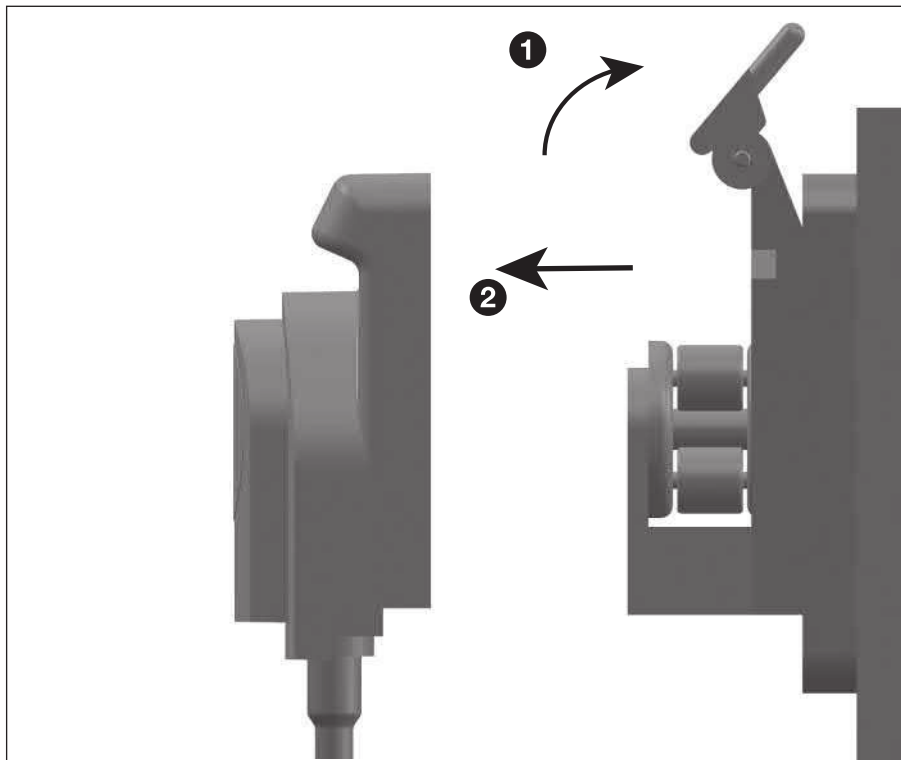

Unlocking of the cover!

- ❶ Fold up lever.
- ❷ Remove cover

Handling

Changing the irrigation tubing set

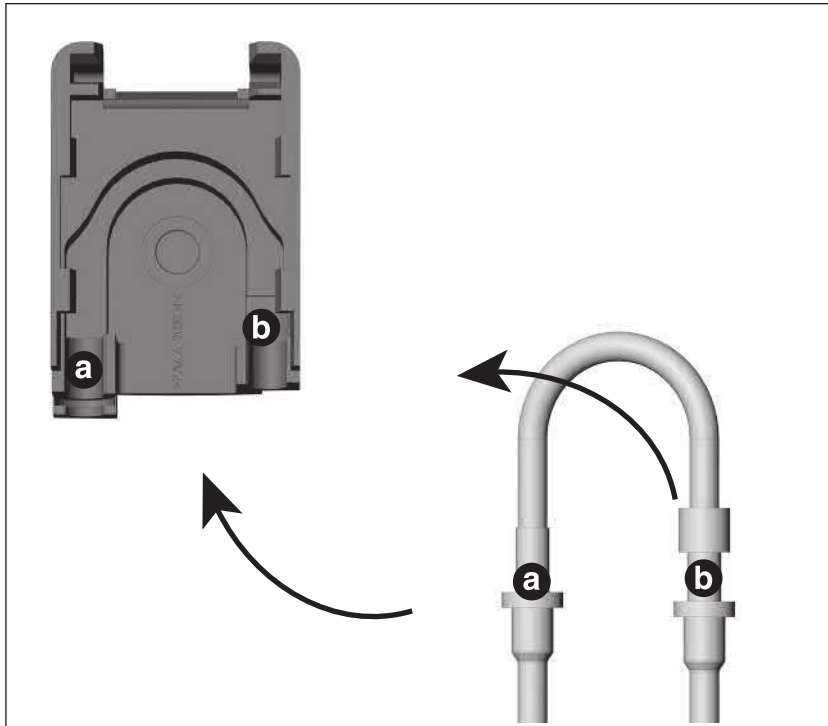

Placement of the irrigation tubing set

- 1 Place the tubing »a« into the guide until the prominent part snaps into the groove
- 2 Place the tubing »b« into guide »b«

Handling

Changing the irrigation tubing set



Irrigation tubing set in place.

Handling

Changing the irrigation tubing set

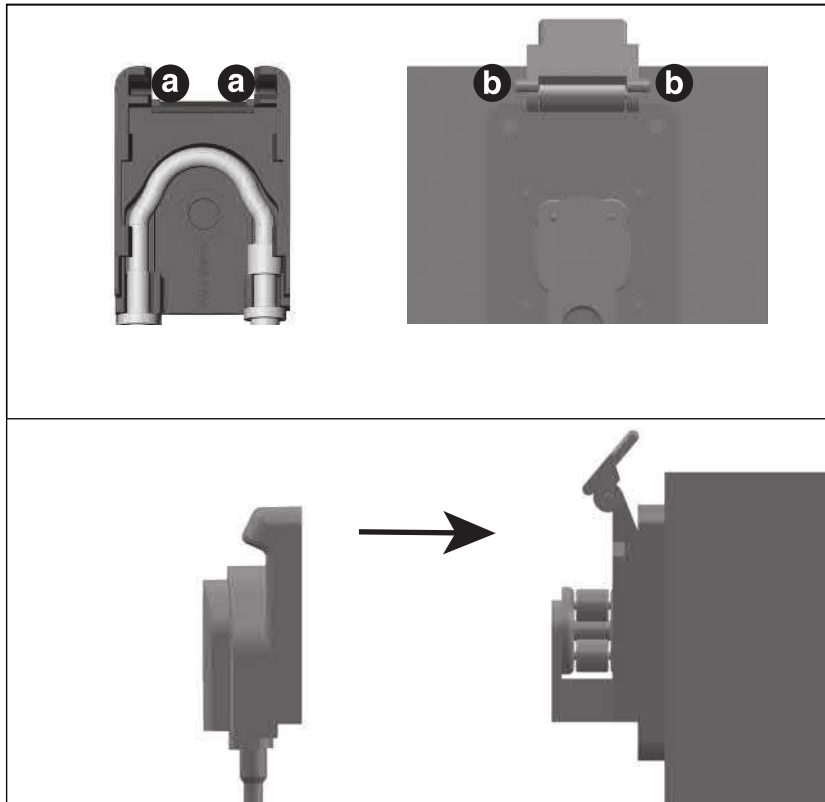

Closing the cover

- 1 Align the cover grooves »a« with the lever pins »b«
- 2 Move the cover onto the pins until it is seated on the pump.

Handling

Exchanging the irrigation tubing set

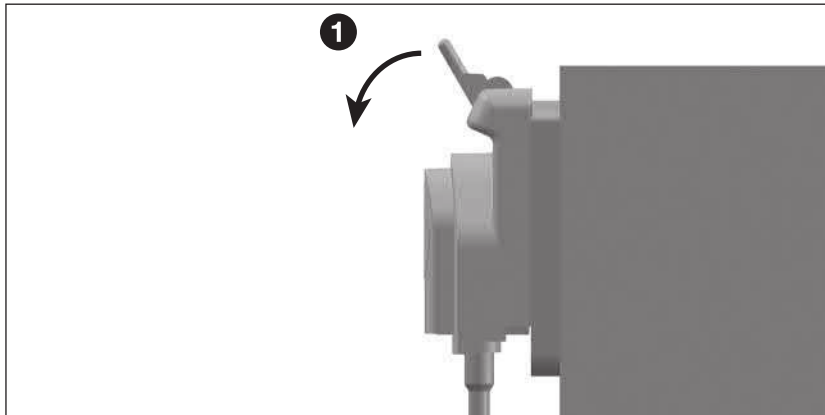

Lock the cover

- ❶ Fold down lever.
- ❷ Cover is locked.

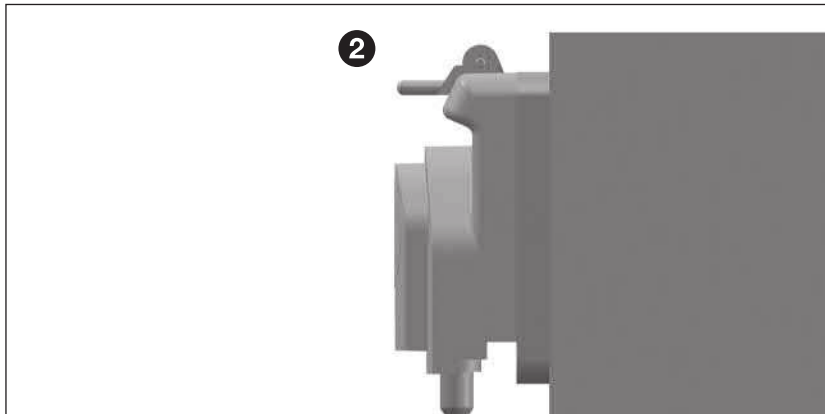

8. Hygiene and maintenance



Follow your local and national laws, directives, standards and guidelines for cleaning.



> Wear protective clothing, safety glasses, face mask and gloves.



> The medical device may be wiped clean.

> The medical device is not approved for mechanical cleaning (thermo washer disinfectors) and sterilization.

> Do not immerse the medical device in water or clean them under running water.

9. Servicing



Regular checking

Regular servicing including the accessories is necessary and should be carried out at least once every three years, unless shorter intervals are prescribed by law.

The inspection must be undertaken by a qualified organisation and must include the following procedures::

- > Visual inspection for external damage
- > Visual inspection of internal components on suspicion of safety interference,

The regular service must only be performed by an authorised W&H service partner.

Repairs and returns

- > In the event of operating malfunctions immediately contact an authorized W&H service partner.
- > Repairs and maintenance work must only be undertaken by an authorized W&H service partner.

10. W&H accessories



Use only original W&H accessories and spare parts or accessories approved by W&H.
Suppliers: W&H partners

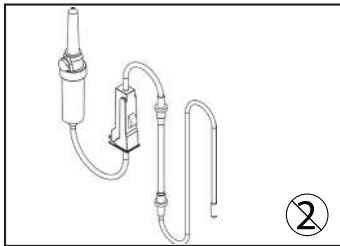

04363600

Irrigation tubing set 2.2 m (6 pcs)

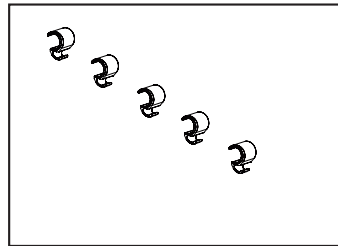

06290600

Hose clips (5 pcs)

11. Technical Data

Insulation Class:	Class B
Weight:	0.2 kg

Ambient conditions	
Temperature during storage and transport:	-40 °C to +70 °C (-40 °F to +158 °F)
Humidity during storage and transport:	8% to 80% (relative), non-condensing
Temperature during operation:	+10 °C to +40 °C (+50 °F to +104 °F)
Humidity during operation:	15% to 80% (relative), non-condensing
Pollution level:	2
Overvoltage category:	II
Altitude:	up to 3,000 m above sea level

12. Disposal



Ensure that the parts are not contaminated on disposal.



Follow your local and national laws, directives, standards and guidelines for disposal.

- > Medical device
- > Waste electrical equipment
- > Packaging

Explanation of warranty terms

This W&H medical device has been manufactured with great care by highly qualified specialists. A wide variety of tests and controls guarantee faultless operation. Please note that claims under warranty can only be validated when all the directions in the Instructions for use have been followed.

As the manufacturer, W&H is liable for material or manufacturing defects within a warranty period of 12 months from the date of purchase. Accessories and consumables are excluded from the warranty.

We accept no responsibility for damage caused by incorrect handling or by repairs carried out by third parties not authorized to do so by W&H!

Claims under warranty accompanied by proof of purchase must be sent to the vendor or to an authorized W&H service partner. The provision of service under warranty extends neither the warranty period nor any other guarantee period.

12 months warranty

Authorised W&H service partners

Visit W&H on the Internet at <http://wh.com>

You can find your nearest W&H service partner at »Service« in the menu.

W&H Austria GmbH, Ignaz-Glaser-Straße 53, 5111 Bürmoos, Austria

t +43 6274 6236-239, f +43 6274 6236-890, E-Mail: office.at@wh.com

W&H CH-AG, Industriepark 9, 8610 Uster ZH, Schweiz

t +41 43 4978484, f +41 43 4978488, E-Mail: service.ch@wh.com

W&H Deutschland GmbH, Raiffeisenstraße 3b, 83410 Laufen, Germany

t +49 8682 8967-0, f +49 8682 8967-11, E-Mail: office.de@wh.com

Manufacturer

W&H Dentalwerk Bürmoos GmbH
Ignaz-Glaser-Straße 53, 5111 Bürmoos, Austria

t +43 6274 6236-0, f +43 6274 6236-55
office@wh.com wh.com

Form No. 50993 AEN
Rev. 000 / 15.10.2018
Subject to alterations

Spittoon valve 3

EN

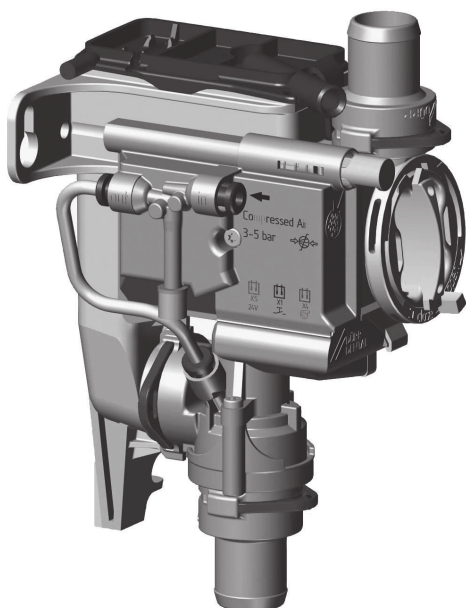

Installation and operating instructions

CE

7560100003L02



 **DÜRR
DENTAL**

2102V003

Contents



Important information

1 About this document	2
1.1 Warnings and symbols	2
1.2 Copyright information	3
2 Safety	3
2.1 Intended purpose	3
2.2 Intended use	3
2.3 Improper use	3
2.4 General safety information	4
2.5 Systems, connection with other devices	4
2.6 Specialist personnel	4
2.7 Electrical safety	4
2.8 Only use original parts	4
2.9 Transport	4
2.10 Disposal	4



Product description

3 Overview	5
3.1 Scope of delivery	5
3.2 Optional items	5
3.3 Wear parts and replacement parts	5
4 Technical data	6
4.1 Type plate	10
4.2 Evaluation of conformity	10
5 Operation	11
5.1 Operating function	11
5.2 Cleaning function	11



Assembly

6 Requirements	12
6.1 Setup options	12
6.2 Preparing for the installation	12
6.3 Hose materials	12

6.4 Information about electrical connections	12
--	----

7 Installation	13
7.1 Installation overview	13
7.2 Installation of the spittoon valve	14
7.3 Establishing the compressed air connection	14
7.4 Electrical connections	14
7.5 Circuit diagram	16
8 Commissioning	17



Usage

9 Disinfection and cleaning	18
9.1 Spittoon valve	18
9.2 Suction system	18
10 Maintenance	19



Troubleshooting

11 Tips for operators and service technicians	20
12 Transporting the unit	21

! Important information

1 About this document

These installation and operating instructions represent part of the unit.

 If the instructions and information in these installation and operating instructions are not followed, Dürr Dental will not be able to offer any warranty or assume any liability for the safe operation and the safe functioning of the unit.

The German version of the installation and operating instructions is the original manual. All other languages are translation of the original manual.

1.1 Warnings and symbols

Warnings

The warnings in this document are intended to draw your attention to possible injury to persons or damage to machinery.

The following warning symbols are used:

 General warning symbol

 Warning – dangerous high voltage

 Biohazard warning

The warnings are structured as follows:

SIGNAL WORD **Description of the type and source of danger**

Here you will find the possible consequences of ignoring the warning

- › Follow these measures to avoid the danger.

The signal word differentiates between four levels of danger:

- › **DANGER**
Immediate danger of severe injury or death
- › **WARNING**
Possible danger of severe injury or death
- › **CAUTION**
Risk of minor injuries
- › **NOTICE**
Risk of extensive material/property damage

Other symbols

These symbols are used in the document and on or in the unit:

 Note, e.g. specific instructions regarding efficient and cost-effective use of the unit.

 Refer to Operating Instructions.

 Wear protective gloves.

 Wear protective goggles.

 Use a face mask.

 Refer to the accompanying electronic documents.

 Cleaning button

 Air

 Vacuum

 Manufacturer

 Order number

 Serial number

1.2 Copyright information

All circuits, processes, names, software programs and units mentioned in this document are protected by copyright.

The Installation and Operating Instructions must not be copied or reprinted, neither in full nor in part, without written authorisation from Dürr Dental.

2 Safety

Dürr Dental has designed and constructed this unit so that when used properly and for the intended purpose it does not pose any danger to people or property.

Despite this, the following residual risks can remain:

- › Personal injury due to incorrect use/misuse
- › Personal injury due to mechanical effects
- › Personal injury due to electric shock
- › Personal injury due to radiation
- › Personal injury due to fire
- › Personal injury due to thermal effects on skin
- › Personal injury due to lack of hygiene, e.g. infection

2.1 Intended purpose

The spittoon valve is designed for installation in a treatment unit in dental surgeries or dental clinics.

The installation of the spittoon valve into a treatment unit helps to avoid suction noises emanating from the spittoon.

2.2 Intended use

The device is designed to be installed between the spittoon and the suction line. The spittoon valve may only process media (e.g. water, saliva, polishing powder, solid materials like fillers, etc.) from the the spittoon.

The spittoon valve can operate max. 1 dental work place.

2.3 Improper use

Any use of this appliance / these appliances above and beyond that described in the Installation and Operating Instructions is deemed to be incorrect usage. The manufacturer cannot be held liable for any damage resulting from incorrect usage. The operator will be held liable and bears all risks.

This includes:

- › Use of silicones, sludge, gypsum or similar substances from the practice.
- › Cleaning and disinfection with chlorine-containing chemicals (such as, e. g., sodium hypochloride).

2.4 General safety information

- › Always comply with the specifications of all guidelines, laws, and other rules and regulations applicable at the site of operation for the operation of this unit.
- › Check the function and condition of the unit prior to every use.
- › Do not convert or modify the unit.
- › Comply with the specifications of the Installation and Operating Instructions.
- › The Installation and Operating Instructions must be accessible to all operators of the unit at all times.

2.5 Systems, connection with other devices

Additional devices connected with medical electrical devices must be proven to conform with their corresponding IEC or ISO standards. All configurations must continue to comply with the standard requirements for medical systems (see IEC 60601-1).

Whoever connects additional devices to medical electrical devices automatically becomes the system configurator and is responsible for ensuring that the system corresponds with the standard requirements for systems. Local laws take priority over the requirements outlined above.

2.6 Specialist personnel

Operation

Unit operating personnel must ensure safe and correct handling based on their training and knowledge.

- › Instruct or have every user instructed in handling the unit.

Installation and repairs

- › Installation, readjustments, alterations, upgrades and repairs must be carried out by Dürr Dental or by qualified personnel specifically approved and authorized by Dürr Dental.

2.7 Electrical safety

- › Comply with all the relevant electrical safety regulations when working on the unit.
- › Never touch the patient and unshielded plug connections on the device at the same time.
- › Replace any damaged cables or plugs immediately.

2.8 Only use original parts

- › Only use accessories and optional items that have been recommended or specifically approved by Dürr Dental.
- › Only use only original wear parts and replacement parts.

2.9 Transport

The original packaging provides optimum protection for the unit during transport.

If required, original packaging for the unit can be ordered from Dürr Dental.



Dürr Dental will not accept any responsibility or liability for damage occurring during transport due to the use of incorrect packaging, even where the unit is still under guarantee.

- › Only transport the unit in its original packaging.
- › Keep the packing materials out of the reach of children.

2.10 Disposal



The unit may be contaminated. Instruct the company disposing of the waste to take the relevant safety precautions.

- › Decontaminate potentially contaminated parts before disposing of them.
- › Uncontaminated parts (e.g. electronics, plastic and metal parts etc.) should be disposed of in accordance with the local waste disposal regulations.
- › If you have any questions about the correct disposal of parts, please contact your dental trade supplier.

3 Overview

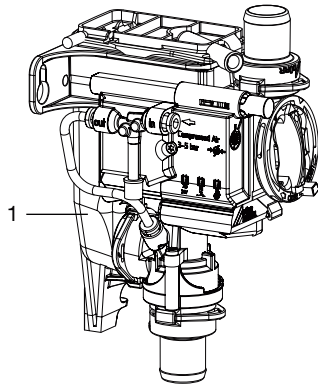

1 Spittoon valve

3.1 Scope of delivery

The following items are included in the scope of delivery (possible variations due to country-specific requirements and/or import regulations):

Spittoon valve 3 7560700xxx

› Spittoon valve

3.2 Optional items

The following optional items can be used with the device:

Switch control panel 7560-520-00

3.3 Wear parts and replacement parts

The following working parts need to be changed at regular intervals (refer to the "Maintenance" section):

Protective strainer 0700-702-06E



Information about replacement parts is available from the portal for authorised specialist dealers at:
www.duerrdental.net.

4 Technical data

Electrical data

Safety low voltage	V	24 AC/DC
Frequency	Hz	50/60
Nominal current	A	0.1
Rated power	W	2.4
Type of protection		IP 21

Electrical data, suction unit relay

Switching voltage		
min.	V	0.03 DC
max.	V	30 DC
Switching current		
min.	mA	10
max.	A	2

Connections

Supply and waste water connection		
DürrConnect	mm	Ø 20
Collection vessel vent connection	mm	Ø 9
Compressed air connection	mm	Ø 4

Media

Compressed air		
min.	bar / MPa	3 / 0.3
max.	bar / MPa	5 / 0.5
Fluid flow rate, max.	l/min	3.5
Fluid temperature, max.	°C	35
Suction system pressure		
max.	mbar/hPa	-200
Absolute	mbar/hPa	800

General data

Duty cycle	%	40
Weight	g	240
Dimensions (H x W x D)	mm	143 x 74 x 112

Ambient conditions during storage and transport

Temperature	°C	-30 to +60
Relative humidity	%	< 95

Ambient conditions during operation

Temperature	°C	+10 to +40
Relative humidity	%	< 70

Ambient conditions during operation

Air pressure	hPa	700 - 1060
--------------	-----	------------

**Electromagnetic compatibility (EMC)
Interference emission measurements**

High-frequency emissions in accordance with CISPR 11		Group 1 Class B
Interference voltage at the power supply connection CISPR 11:2009+A1:2010		Compliant
Electromagnetic interference radiation CISPR 11:2009+A1:2010		Compliant
Emission of harmonics IEC 61000-3-2:2005+A1:2008+A2:2009		N/A
Voltage changes, voltage fluctuations and flicker emissions IEC 61000-3-3:2013		N/A
N/A = not applicable		

**Electromagnetic compatibility (EMC)
Interference immunity measurements on the supply input**

Immunity to fast electrical transients/bursts – AC mains voltage IEC 61000-4-4:2012 ± 2 kV 100 kHz repetition rate		Compliant
Immunity to surges, line-to-line IEC 61000-4-5:2005 ± 0.5 kV, ± 1 kV		Compliant
Immunity to surges, line-earth IEC 61000-4-5:2005 ± 0.5 kV, ± 1 kV, ± 2 kV		N/A
Immunity to conducted disturbances, induced by radio-frequency fields – AC mains voltage IEC 61000-4-6:2013 3 V 0.15–80 MHz 6 V ISM frequency bands 0.15–80 MHz 80% AM at 1 kHz		Compliant
Immunity to voltage dips, short interruptions and voltage variations IEC 61000-4-11:2004		Compliant
N/A = not applicable		

EN

**Electromagnetic compatibility (EMC)
Interference immunity measurements SIP/SOP**

Immunity to electrical fast transients/bursts – I/O, SIP/SOP ports
IEC 61000-4-4:2012
± 1 kV
100 kHz repetition rate
Compliant

Immunity to impulse voltages, conductor to earth
IEC 61000-4-5:2005
± 2 kV
N/A

Immunity to conducted disturbances, induced by radio-frequency fields – SIP/SOP ports
IEC 61000-4-6:2013
3 V
0.15–80 MHz
6 V
ISM frequency bands
0.15–80 MHz
80% AM at 1 kHz
Compliant

N/A = not applicable

**Electromagnetic compatibility (EMC)
Interference immunity measurements on the cover**

Immunity to electrostatic discharge
IEC 61000-4-2:2008
± 8 kV contact
± 2 kV, ± 4 kV, ± 8 kV, ± 15 kV air
Compliant

Immunity to high-frequency electromagnetic fields
IEC 61000-4-3:2006+A1:2007+A2:2010
3 V/m
80 MHz–2.7 GHz
80% AM at 1 kHz
Compliant

Immunity to near fields of wireless HF communication devices
IEC 61000-4-3:2006+A1:2007+A2:2010
Refer to the table with immunity to interference levels for near fields of wireless HF communication devices.
Compliant

Immunity to power frequency magnetic fields
IEC 61000-4-8:2009
30 A/m
30 Hz or 60 Hz
Compliant

Immunity to interference table, near fields of wireless HF communication devices

Radio service	Frequency band MHz	Test level V/m
TETRA 400	380 - 390	27
GMRS 460 FRS 460	430 - 470	28

Immunity to interference table, near fields of wireless HF communication devices

Radio service	Frequency band MHz	Test level V/m
LTE band 13, 17	704 - 787	9
GSM 800/900 TETRA 800 iDEN 820 CDMA 850 LTE band 5	800 - 960	28
GSM 1800 CDMA 1900 GSM 1900 DECT LTE band 1, 3, 4, 25 UMTS	1700 - 1990	28
Bluetooth WLAN 802.11 b/g/n RFID 2450 LTE band 7	2400 - 2570	28
WLAN 802.11 a/n	5100 - 5800	9

EN 4.1 Type plate

The type plates are located on the side of the fluid collector.

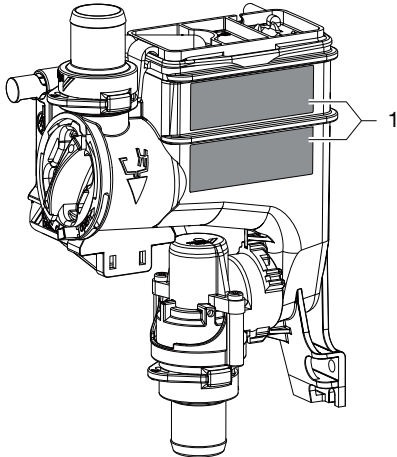

1 Type plate

4.2 Evaluation of conformity

This device has been subjected to conformity acceptance testing in accordance with the current relevant European Union guidelines. This equipment conforms to all relevant requirements.

5 Operation

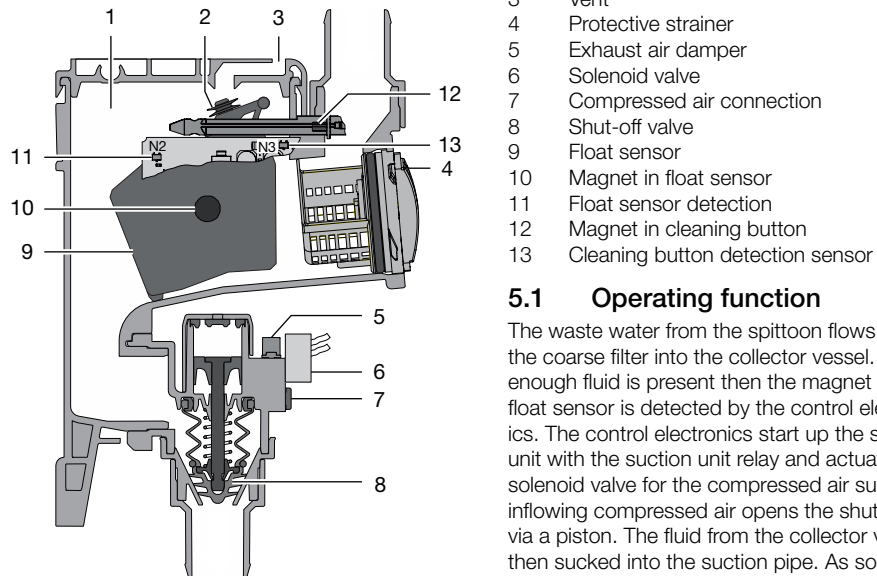

Fig. 1: Idle phase

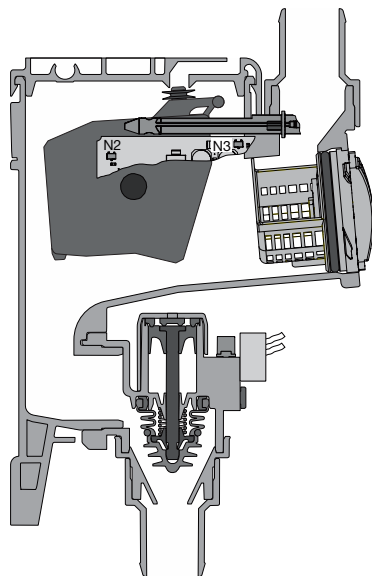

Fig. 2: Operational phase

1 Fluid collector

- 2 Air extraction seal
- 3 Vent
- 4 Protective strainer
- 5 Exhaust air damper
- 6 Solenoid valve
- 7 Compressed air connection
- 8 Shut-off valve
- 9 Float sensor
- 10 Magnet in float sensor
- 11 Float sensor detection
- 12 Magnet in cleaning button
- 13 Cleaning button detection sensor

5.1 Operating function

The waste water from the spittoon flows through the coarse filter into the collector vessel. If enough fluid is present then the magnet in the float sensor is detected by the control electronics. The control electronics start up the suction unit with the suction unit relay and actuate the solenoid valve for the compressed air supply. The inflowing compressed air opens the shut-off valve via a piston. The fluid from the collector vessel is then sucked into the suction pipe. As soon as the fill level in the collector vessel has dropped, this is detected by the control electronics and the solenoid valve is switched off. While waste water continues to flow in from the spittoon the collector vessel refills and the process starts again from the beginning.

5.2 Cleaning function

The cleaning function is activated by permanent pressure on the yellow cleaning button on the spittoon valve or on the cleaning button on the switch control panel (if present). As a result the solenoid valve for the compressed air supply, and therefore the shut-off valve, is opened and the suction unit relay is actuated in order to start up the suction unit.

The cleaning and disinfection solutions can now be aspirated without hindrance through the spittoon valve into the suction pipe and into the suction unit. A suction noise can be heard at the spittoon.



6 Requirements

6.1 Setup options

- › Installation in treatment units in dental surgeries or dental clinics.

6.2 Preparing for the installation

Prior to installation of the spittoon valve the following media should be checked and if necessary adjusted; refer also to "4 Technical data":

- › Vacuum of the suction system
- › Compressed air supply
- › Water amount from the spittoon



Do not remove the gold collector or the coarse sieves from the spittoon.

6.3 Hose materials

For waste connections and suction lines only use the following hose types:

- › Flexible spiral hoses made of PVC with integrated spiral or equivalent hoses
- › Hoses that are resistant to dental disinfectants and chemicals



Plastic hoses will display signs of ageing over time. Therefore, they should be inspected regularly and replaced as necessary.

The following types of hoses must not be used:

- › Rubber hoses
- › Hoses made completely of PVC
- › Hoses that are not sufficiently flexible

6.4 Information about electrical connections

- › The supply voltage to the device must satisfy the requirements for two means of patient protection (MOPP) as set out in IEC 60601-1 in relation to the supply network.
- › The supply voltage must satisfy the following voltage/power requirements:
24 V AC/DC, 50/60 Hz, min. 2.4 VA

7 Installation

7.1 Installation overview

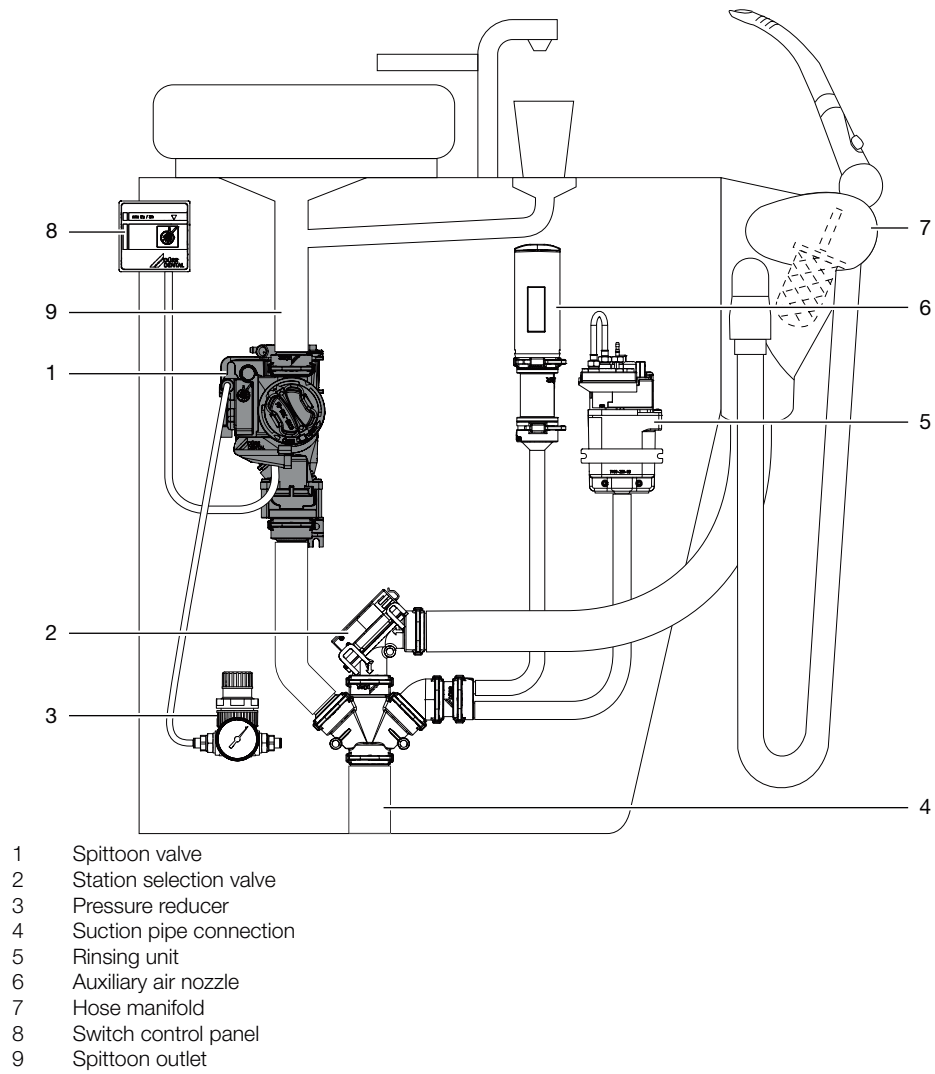

EN 7.2 Installation of the spittoon valve

 The cleaning function can be activated via the yellow button. For this reason the spittoon valve should be positioned in an easily accessible location. If this is not possible, a separate switch control panel can be used as an optional accessory.

- › Disconnect the treatment unit from the power supply and secure it so that it cannot be switched back on again.
- › Firmly screw the spittoon valve onto a suitable place on the treatment unit.
- › Connect the drain hose from the spittoon to the inlet of the spittoon valve.
- › Connect the outlet of the spittoon valve to the suction pipe.

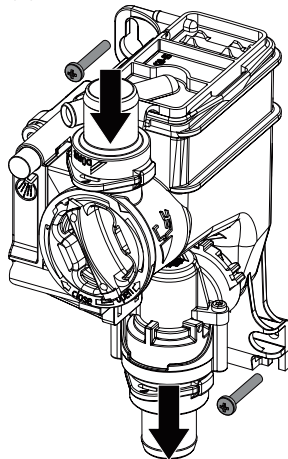

7.3 Establishing the compressed air connection

- › Disconnect a suitable compressed air line from the treatment unit.
- › Install a T-piece with 4 mm branch in the compressed air line.
- › Connect a compressed air hose to the T-piece.

- › Route the compressed air hose to the spittoon valve, cut it off straight and insert it.

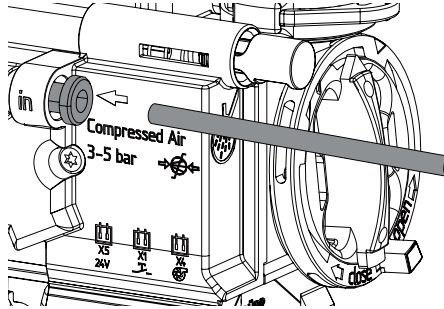

 To pull off the compressed air hose from the spittoon valve, press the black sleeve on the compressed air connection inwards.

7.4 Electrical connections

 Prior to working on the unit or in case of danger, disconnect it from the mains.

 The requirements of IEC 60601-1 must be satisfied during installation.

- › Open the cover of the control electronics.
- › Route the power supply and control line to the spittoon valve.
- › Attach the connector to the connection lines.
- › Plug in the connector at the corresponding positions on the control electronics.

› Secure the connection lines with cable ties to the housing.

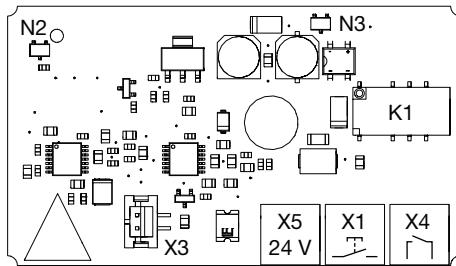
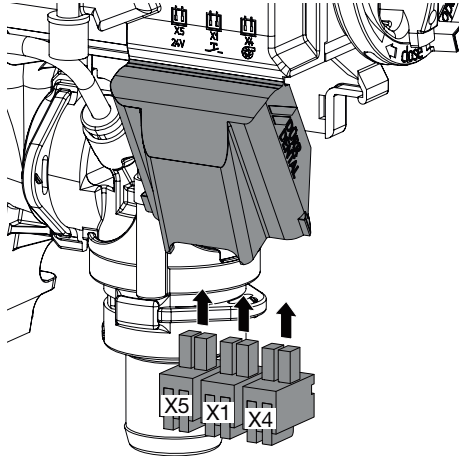

- X1 Cleaning button for switch control panel
- X3 Solenoid valve
- X4 Control line for suction unit
- X5 Power supply
- K1 Suction unit relay
- N2 Float sensor detection
- N3 Cleaning button detection sensor

EN 7.5 Circuit diagram

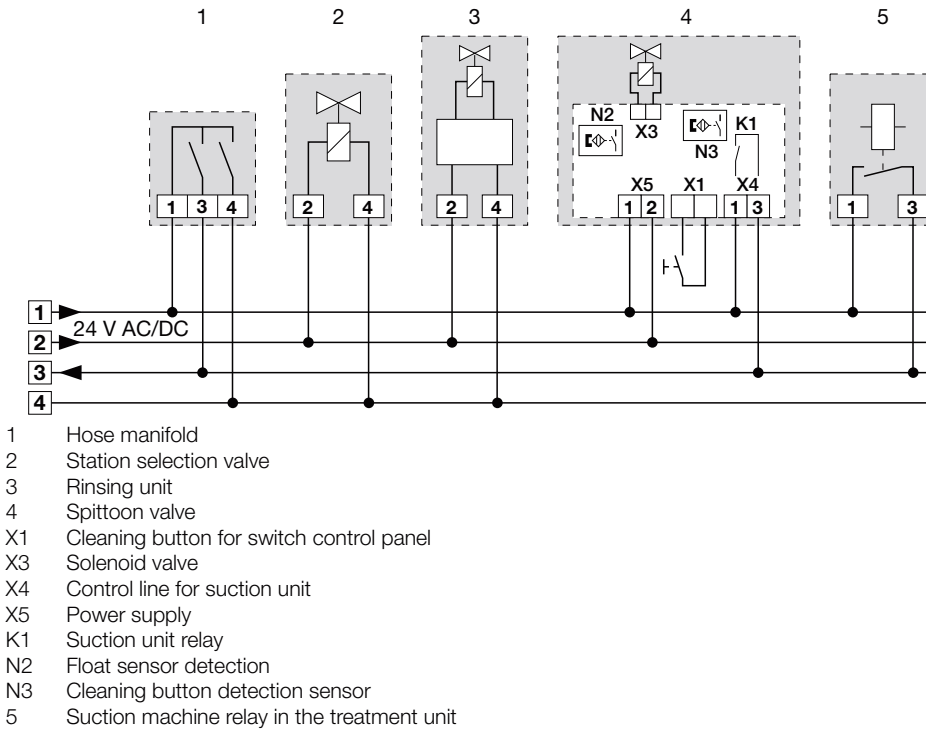

8 Commissioning

- › Turn on the unit power switch or the main surgery switch.
- › Carry out a function check of the system.
- › Check all connections for leak tightness.
- › Carry out an electrical safety check in accordance with applicable regulations (e.g. regulations concerning set up, operation and application of medical devices) and record the results as appropriate, e.g. in the technical log book.

9 Disinfection and cleaning



NOTICE

Device malfunctions or damage due to use of incorrect media

Guarantee claims may become invalid as a result.

- › Do not use any foaming agents such as household cleaning agents or instrument disinfectants.
- › Do not use abrasive cleaners.
- › Do not use agents containing chlorine.
- › Do not use any solvents like acetone.

Dürr Dental recommends

- › For disinfection and cleaning: Orotol plus or Orotol ultra
- › For cleaning: MD 555 cleaner

Only these products have been tested by Dürr Dental.

When using prophylaxis powders, Dürr Dental recommends the water-soluble Lunos prophylaxis powders in order to protect the Dürr Dental suction systems.

9.1 Spittoon valve

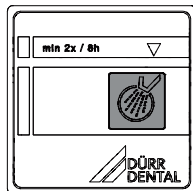
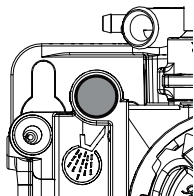

- › Switch on the rinsing for the spittoon.
- › Keep pressing the yellow cleaning button of the spittoon valve or the cleaning button on the switch control panel (if present) until rinsing of the spittoon is finished.
- › Pour disinfection solution into the spittoon and at the same time press the yellow cleaning button of the spittoon valve or the cleaning button on the switch control panel (if present) until the disinfection solution has been aspirated.

9.2 Suction system

After every treatment

- › Aspirate a glass of cold water through the large and the small suction hoses. Do this even if only the small suction hose was actually used during treatment.



Suction through the large suction hose causes a large amount of air to be drawn up, thereby considerably increasing the cleaning effect.

Daily after the end of treatment



After higher workloads before the midday break and in the evening

The following are required for disinfection/cleaning:

- ✓ Non-foaming disinfectant/cleaning agent that is compatible with the materials.
- ✓ Unit care system, e.g. OroCup
- › To pre-clean, suck up 2 litres of water with the care system.
- › Aspirate the disinfection/cleaning agent with the care system.

Once or twice a week before the midday break



Under harsher conditions (e.g. hard water or frequent use of prophylaxis powders) 1x daily before the midday break

The following are required for cleaning:

- ✓ Special non-foaming detergent for suction units that is compatible with the materials.
- ✓ Unit care system, e.g. OroCup
- › To pre-clean, suck up 2 litres of water with the care system.
- › Aspirate the cleaning agent with the care system.
- › Rinse with ca. 2 l water after the application time.

10 Maintenance



All maintenance work must be performed by a qualified expert or by one of our Service Technicians.



WARNING

Infection due to contaminated unit

- › Clean and disinfect the suction before working on the unit.
- › Wear protective equipment when working (e. g. impermeable gloves, protective goggles and mouth and nose protection).



Prior to working on the unit or in case of danger, disconnect it from the mains.

Maintenance interval	Maintenance work
Monthly	<ul style="list-style-type: none"> › Press the yellow cleaning button to empty the collection vessel. › Clean the yellow coarse filter or replace it if required.
Annually	<ul style="list-style-type: none"> › Check compressed air supply. * › Perform a functional test.
Every 3 years	<ul style="list-style-type: none"> › Clean the float monitor in the collection vessel. * › Clean the seal on the float sensor for ventilation and replace if required. *

* Only to be performed by service technicians.

11 Tips for operators and service technicians



Any repairs exceeding routine maintenance may only be carried out by qualified personnel or our service.



WARNING

Infection due to contaminated unit

- › Clean and disinfect the suction before working on the unit.
- › Wear protective equipment when working (e. g. impermeable gloves, protective goggles and mouth and nose protection).



Prior to working on the unit or in case of danger, disconnect it from the mains.

Error	Possible cause	Remedy
Spittoon valve not working	No power supply	› Check power supply and restore. *
	Faulty connections	› Check the plug connections. *
	Relay not switching	› Check the switching function of the relay. *
	No compressed air present	› Check the compressed air supply of the spittoon valve. *
	Sensor defective	› Check the function of the sensor with the aid of the button. › Check the function by manually moving the float sensor.
Suction unit does not start up or runs continuously	Float sensor does not move in its housing	› Clean the housing and float sensor. * › Insert the float sensor correctly. *
Fluid does not drain off	Drain blocked	› Clean the drain line. * › Check whether the filter is blocked, clean if necessary.

* Only to be done by service technicians.

12 Transporting the unit



WARNING

Infection due to contaminated unit

- › Disinfect the unit before transport.
- › Close all media connections.



Wear protective equipment to avoid any risk of infection (e.g. liquid-tight protective gloves, protective goggles, face mask).

- › Before disassembly, clean and disinfect the suction unit and the unit using a suitable disinfectant approved by Dürr Dental.
- › Disinfect a defective unit using a suitable surface disinfection agent.
- › Seal all connections with sealing caps.
- › Pack the unit securely in preparation for transport.

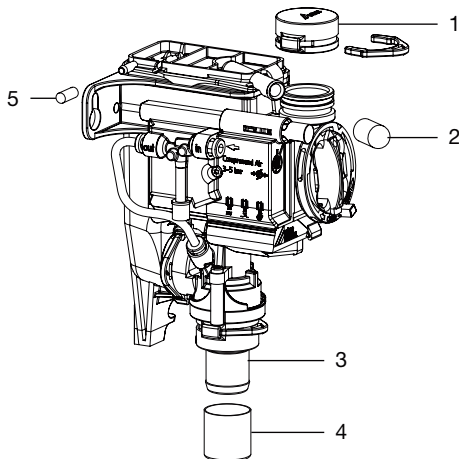

- 1 DürrConnect dummy bushing (order no. 0700-700-10E)
- 2 Protective cap (order no. 9000-412-85)
- 3 DürrConnect hose connector socket Ø 20 mm (order no. 0700-700-20E)
- 4 Protective cap (order no. 9000-412-98)
- 5 Sealing cap (order no. 9000-310-002)



Hersteller / Manufacturer:

DÜRR DENTAL SE
Höpfigheimer Str. 17
74321 Bietigheim-Bissingen
Germany
Fon: +49 7142 705-0
www.duerrdental.com
info@duerrdental.com



CAS 1 Combi-Separator

EN

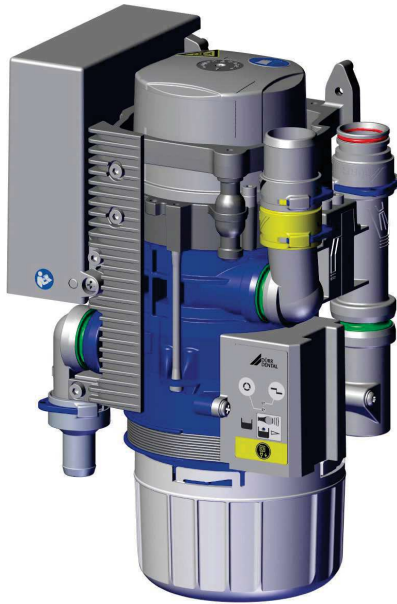

Installation and operating instructions

CE

7117100018L30



 **DÜRR
DENTAL**

2011V003

Contents



Important information

1	About this document	3
1.1	Warnings and symbols	3
1.2	Copyright information	4
2	Safety	4
2.1	Intended purpose	4
2.2	Intended use	4
2.3	Improper use	4
2.4	Systems, connection with other devices	5
2.5	General safety information	5
2.6	Specialist personnel	5
2.7	Notification requirement of serious incidents	5
2.8	Electrical safety	5
2.9	Only use original parts	6
2.10	Transport	6
2.11	Disposal	6



Product description

3	Overview	7
3.1	Scope of delivery	7
3.2	Accessories	7
3.3	Optional items	7
3.4	Consumables	7
3.5	Wear parts and replacement parts	7
4	Technical data	8
4.1	CAS 1 Combi-Separator	8
4.2	Type plate	12
4.3	Evaluation of conformity	12
4.4	Approvals	12
5	Operation	13
5.1	Operation	14
5.2	Separation	14
5.3	Spittoon connections	14
5.4	Station selection valve / safety valve	14

5.5	Amalgam separation	14
5.6	Sediment level measurement	15
5.7	Operating problems	15
5.8	Service key	15

EN



Assembly

6	Requirements	16
6.1	Installation/setup room	16
6.2	Setup options	16
6.3	Hose materials	16
6.4	Installation and routing of hoses and pipes	16
6.5	Information about electrical connections	16
6.6	Information about connecting cables	16
7	Installation	17
7.1	Combining devices safely	17
7.2	Installation of the CAS 1 in treatment units	17
7.3	Electrical connections, controller	18
7.4	Electrical connections	19
8	Commissioning	20
9	Service program	21
10	Description of the service program	22
10.1	Service program ON/OFF	22
10.2	Display test	22
10.3	Sediment level measurement	22
10.4	Motor start - motor braking	22
10.5	Input and output signals	22



Usage

11	Display/handling	23
11.1	Ready for operation	23
11.2	Amalgam collector vessel is 95% full	23
11.3	Amalgam collector vessel is 100% full	23

Contents

EN

11.4	Amalgam collector vessel not in position	23
11.5	Motor fault	23
12	Disinfection and cleaning	24
12.1	After every treatment	24
12.2	Daily after the end of treatment	24
12.3	Once or twice a week before the midday break	25
13	Replace the amalgam collector vessel	25
13.1	Disposal of the collector vessel	25
14	Maintenance	27
14.1	Tests	28



Troubleshooting

15	Tips for operators and service technicians	29
16	Transporting the unit	32
16.1	Close CAS 1	32



Appendix

17	Handover record	33
-----------	----------------------------------	-----------

 **Important information****1 About this document**

These installation and operating instructions represent part of the unit.

 If the instructions and information in these installation and operating instructions are not followed, Dürr Dental will not be able to offer any warranty or assume any liability for the safe operation and the safe functioning of the unit.

The German version of the installation and operating instructions is the original manual. All other languages are translation of the original manual. These installation and operating instructions apply to:

CAS 1

REF: 7117-100-51

1.1 Warnings and symbols**Warnings**

The warnings in this document are intended to draw your attention to possible injury to persons or damage to machinery.

The following warning symbols are used:

 General warning symbol

 Biohazard warning

The warnings are structured as follows:

 **SIGNAL WORD**
Description of the type and source of danger

Here you will find the possible consequences of ignoring the warning

› Follow these measures to avoid the danger.

The signal word differentiates between four levels of danger:

- **DANGER**
Immediate danger of severe injury or death
- **WARNING**
Possible danger of severe injury or death
- **CAUTION**
Risk of minor injuries
- **NOTICE**
Risk of extensive material/property damage

EN

Other symbols

These symbols are used in the document and on or in the unit:

 Note, e.g. specific instructions regarding efficient and cost-effective use of the unit.

 Refer to Operating Instructions.

 Wear protective gloves.

 Disconnect all power from the unit.

 Hose manifold connection

 Spittoon connections

 Suction unit connection

 Drain connection

 Unit in operation

 Unit operation interrupted





 Audible signal/melody sounds

 Do not reuse

 CE labelling

 Important information

EN

-  Order number
-  Serial number
-  Medical device
-  Health Industry Bar Code (HIBC)
-  Manufacturer

1.2 Copyright information

All circuits, processes, names, software programs and units mentioned in this document are protected by copyright.

The Installation and Operating Instructions must not be copied or reprinted, neither in full nor in part, without written authorisation from Dürr Dental.

2 Safety

Dürr Dental has designed and constructed this unit so that when used properly and for the intended purpose it does not pose any danger to people or property.

Despite this, the following residual risks can remain:

- Personal injury due to incorrect use/misuse
- Personal injury due to mechanical effects
- Personal injury due to electric shock
- Personal injury due to radiation
- Personal injury due to fire
- Personal injury due to thermal effects on skin
- Personal injury due to lack of hygiene, e.g. infection

2.1 Intended purpose

The CAS 1 Combi-Separator is designed for continuous separation of liquids and air and for separation of amalgam from the entire waste water from dental treatment units.

2.2 Intended use

The Combi-Separator is designed for installation in the suction line of a dry suction system after the hose manifold and spittoon.

Service, maintenance, recurring tests and cleaning must be performed in accordance with the manufacturer's information.

The permissible flow rate must be observed.

A rinsing unit is required for surgical procedures and for procedures using prophy powders.

The disposable amalgam containers must only be used once.

2.3 Improper use

Any use of this appliance / these appliances above and beyond that described in the Installation and Operating Instructions is deemed to be incorrect usage. The manufacturer cannot be held liable for any damage resulting from incorrect usage. The operator will be held liable and bears all risks.

This includes:

- Use for separation of dust, sludge, plaster or similar.
- Use in conjunction with flammable or explosive mixtures.
- Installation in a manner that does not comply with the installation instructions, in particular installation in rooms containing a potentially explosive atmosphere.
- Cleaning and disinfection with agents containing sodium hypochlorite or potassium hypochlorite.

2.4 Systems, connection with other devices

Additional devices connected with medical electrical devices must be proven to conform with their corresponding IEC or ISO standards. All configurations must continue to comply with the standard requirements for medical systems (see IEC 60601-1).

Whoever connects additional devices to medical electrical devices automatically becomes the system configurator and is responsible for ensuring that the system corresponds with the standard requirements for systems. Local laws take priority over the requirements outlined above.

2.5 General safety information

- › Always comply with the specifications of all guidelines, laws, and other rules and regulations applicable at the site of operation for the operation of this unit.
- › Check the function and condition of the unit prior to every use.
- › Do not convert or modify the unit.
- › Comply with the specifications of the Installation and Operating Instructions.
- › The Installation and Operating Instructions must be accessible to all operators of the unit at all times.

2.6 Specialist personnel

Operation

Unit operating personnel must ensure safe and correct handling based on their training and knowledge.

- › Instruct or have every user instructed in handling the unit.

Installation and repairs

- › Installation, readjustments, alterations, upgrades and repairs must be carried out by Dürr Dental or by qualified personnel specifically approved and authorized by Dürr Dental.

2.7 Notification requirement of serious incidents

The operator/patient is required to report any serious incident that occurs in connection with the device to the manufacturer and to the competent authority of the Member State in which the operator and/or patient is established/resident.

2.8 Electrical safety

- › Comply with all the relevant electrical safety regulations when working on the unit.
- › Never touch the patient and unshielded plug connections on the device at the same time.
- › Replace any damaged cables or plugs immediately.

Observe the EMC rules concerning medical devices

- › The unit is intended for use in professional healthcare facilities (in accordance with IEC 60601-1-2). If the appliance is operated in another environment, potential effects on electromagnetic compatibility must be taken into account.
- › Do not operate the unit in the vicinity of HF surgical instruments or MRT equipment.
- › Keep a minimum distance of 30 cm between the unit and mobile radio devices.
- › Note that cable lengths and cable extensions have effects on electromagnetic compatibility.



NOTICE

Negative effects on the EMC due to non-authorised accessories

- › Use only Dürr Dental parts or accessories specifically approved by Dürr Dental.
- › Using any other accessories may result in increased electromagnetic interference emissions or the unit having reduced electromagnetic immunity, leading to an erroneous operation mode.



NOTICE

Erroneous operation mode due to use immediately adjacent to other devices or with other stacked devices

- › Do not stack the unit together with other devices.
- › If this is unavoidable, the unit and other devices should be monitored in order to ensure that they are working correctly.

- › Untaminated parts (e.g. electronics, plastic and metal parts etc.) should be disposed of in accordance with the local waste disposal regulations.
- › If you have any questions about the correct disposal of parts, please contact your dental trade supplier.



An overview of the waste keys for Dürr Dental products can be found in the download area at www.duerdental.com (document no. P007100155).

2.9 Only use original parts

- › Only use accessories and optional items that have been recommended or specifically approved by Dürr Dental.
- › Only use only original wear parts and replacement parts.



DÜRR MEDICAL accepts no liability for damages or injury resulting from the use of non-approved accessories or optional accessories, or from the use of non-original wear parts or replacement parts.

The use of non-approved accessories, optional accessories or non-genuine wear parts / replacement parts (e.g. mains cables) can have a negative effect in terms of electrical safety and EMC.

2.10 Transport

The original packaging provides optimum protection for the unit during transport.

If required, original packaging for the unit can be ordered from Dürr Dental.



Dürr Dental will not accept any responsibility or liability for damage occurring during transport due to the use of incorrect packaging, even where the unit is still under guarantee.

- › Only transport the unit in its original packaging.
- › Keep the packing materials out of the reach of children.

2.11 Disposal



The unit may be contaminated. Instruct the company disposing of the waste to take the relevant safety precautions.

- › Decontaminate potentially contaminated parts before disposing of them.

 Product description

3 Overview

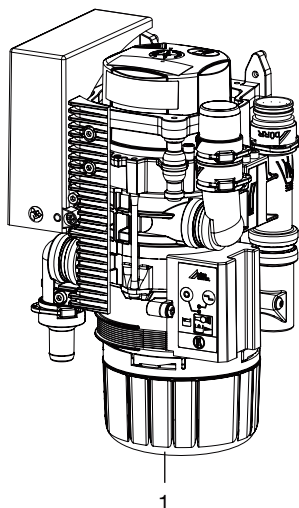

1 CAS 1 Combi-Separator

3.1 Scope of delivery

 The scope of delivery can vary slightly depending on the version.

The following items are included in the scope of delivery:

CAS 1 **7117-100-51**

- Combi-Separator
- Replacement disposable amalgam container
- Installation and operating instructions
- Operating Handbook

3.2 Accessories

The following items are required for operation of the device, depending on the application:

Disposable amalgam container . . . 7117-033-00

3.3 Optional items

The following optional items can be used with the device:

Various installation sets are available on request.

Display panel 7805-116-00E

Cable for display panel, 1 m 9000-119-043

Cable for display panel, 3 m 9000-119-042

Station selection valve	7560-500-60
Station selection valve for CAS 1 /	
CS 1	7560-500-80
Vario rinsing unit	7100-260-50
OroCup care system	0780-350-00
Test vessel	7117-064-00
Rinsing unit II	7100-250-50
Safety transformer 24 V, 100 VA . .	9000-150-46
Housing	7117-800-51

EN

3.4 Consumables

The following materials are consumed during operation of the device and must be ordered separately:

Disposable amalgam container . . . 7117-033-00

DürrConnect protective strainer,
5 pieces 0700-700-18E

DürrConnect protective strainer,
5 pieces 0700-700-28E

Orotol plus (2.5 litre bottle) CDS110P6150

MD 550 spittoon bowl cleaner
(750 ml bottle) CCS550C4500

MD 555 cleaner (2.5 litre bottle) . . CCS555C6150

3.5 Wear parts and replacement parts

The following working parts need to be changed at regular intervals (refer to the "Maintenance" section):

Bellows 7117-420-25E

Service kit (3-year interval) 7117-980-32

Service kit (5-year interval) 7117-980-30

 Information about replacement parts is available from the portal for authorised specialist dealers at:
www.duerrdental.net.

4 Technical data

4.1 CAS 1 Combi-Separator

EN

Electrical data – centrifuge motor		
Rated voltage	V	24 AC
Frequency	Hz	50 / 60
Rated power	VA	100
Current consumption in stand-by	mA	200
Signal input from hose manifold	V	24 AC
	Hz	50/60
Signal output	V	24 DC
	mA	300
Media		
Air flow volume	l/min	≤ 350
Flow rate		high
The suction system must be suitable for a high flow rate in accordance with EN ISO 10637.		
Max. pressure	hPa/mbar	-160
Min. volume of aspiration fluid	l/min	≥ 0.1
max.	l/min	≤ 1.0
Water supply, spittoon	l/min	≤ 3
Total flow of waste liquids	l/min	≤ 4
Usable volume in amalgam collecting container	ccm	approx. 90
Replacement interval		4 - 6 months
General data		
Drive motor nominal speed	rpm	2800
Operating mode		S5 95% duty cycle*
Type of protection		IP 20
Protection class		II
Noise level ** approx.	dB(A)	55
Dimensions (H x W x D)	mm	255 x 157 x 110
Weight, approx.	kg	2.7
Separation rate	%	≥ 95
* DC = duty cycle		
** Noise level in accordance with EN ISO 3746		
Ambient conditions during storage and transport		
Temperature	°C	-10 to +60
Relative humidity	%	< 95

Ambient conditions during operation

Temperature	°C	+10 to +40
Relative humidity	%	< 70

Classification

Medical Device Class	I
----------------------	---

EN

Electromagnetic compatibility (EMC)**Interference emission measurements**

High-frequency emissions in accordance with CISPR 11	Group 1 Class B
Interference voltage at the power supply connection CISPR 11:2009+A1:2010	Compliant
Electromagnetic interference radiation CISPR 11:2009+A1:2010	Compliant
Emission of harmonics IEC 61000-3-2:2005+A1:2008+A2:2009	Compliant
Voltage changes, voltage fluctuations and flicker emissions IEC 61000-3-3:2013	Compliant

Electromagnetic compatibility (EMC)**Interference immunity measurements**

Immunity to electrostatic discharge IEC 61000-4-2:2008	Compliant
Immunity to high-frequency electromagnetic fields IEC 61000-4-3:2006+A1:2007+A2:2010	Compliant
Immunity to near fields of wireless HF communication devices IEC 61000-4-3:2006+A1:2007+A2:2010	Compliant
Immunity to fast electrical transients/bursts – AC mains voltage IEC 61000-4-4:2012	Compliant
Immunity to electrical fast transients/bursts – I/O, SIP/SOP ports IEC 61000-4-4:2012	Compliant
Immunity to interference, surges IEC 61000-4-5:2005	Compliant
Immunity to conducted disturbances, induced by radio-frequency fields – AC mains voltage IEC 61000-4-6:2013	Compliant
Immunity to conducted disturbances, induced by radio-frequency fields – SIP/SOP ports IEC 61000-4-6:2013	Compliant
Immunity to power frequency magnetic fields IEC 61000-4-8:2009	Compliant

EN

**Electromagnetic compatibility (EMC)
Interference immunity measurements**

Immunity to voltage dips, short interruptions and voltage variations
IEC 61000-4-11:2004

Compliant

Immunity to interference levels, near fields of wireless HF communication devices

Radio service	Frequency band MHz	Test level V/m
TETRA 400	380 - 390	27
GMRS 460 FRS 460	430 - 470	28
LTE band 13, 17	704 - 787	9
GSM 800/900 TETRA 800 iDEN 820 CDMA 850 LTE band 5	800 - 960	28
GSM 1800 CDMA 1900 GSM 1900 DECT LTE band 1, 3, 4, 25 UMTS	1700 - 1990	28
Bluetooth WLAN 802.11 b/g/n RFID 2450 LTE band 7	2400 - 2570	28
WLAN 802.11 a/n	5100 - 5800	9

**Electromagnetic compatibility (EMC)
Interference immunity measurements on the supply input**

Immunity to fast electrical transients/bursts – AC mains voltage
IEC 61000-4-4:2012
± 2 kV
100 kHz repetition rate

Compliant

Immunity to surges, line-to-line
IEC 61000-4-5:2005
± 0.5 kV, ± 1 kV

Compliant

Immunity to surges, line-earth
IEC 61000-4-5:2005
± 0.5 kV, ± 1 kV, ± 2 kV

N/A

Electromagnetic compatibility (EMC)		EN
Interference immunity measurements on the supply input		
Immunity to conducted disturbances, induced by radio-frequency fields – AC mains voltage IEC 61000-4-6:2013 3 V 0.15–80 MHz	Compliant	
ISM frequency bands 0.15–80 MHz 80% AM at 1 kHz		
Immunity to voltage dips, short interruptions and voltage variations IEC 61000-4-11:2004	Compliant	
N/A = not applicable		
Electromagnetic compatibility (EMC)		EN
Interference immunity measurements SIP/SOP		
Immunity to electrostatic discharge IEC 61000-4-2:2008 ± 8 kV contact ± 2kV, ± 4 kV, ± 8 kV, ± 15 kV air	Compliant	
Immunity to electrical fast transients/bursts – I/O, SIP/SOP ports IEC 61000-4-4:2012 ± 1 kV 100 kHz repetition rate	Compliant	
Immunity to impulse voltages, conductor to earth IEC 61000-4-5:2005 ± 2 kV	N/A	
Immunity to conducted disturbances, induced by radio-frequency fields – SIP/SOP ports IEC 61000-4-6:2013 3 V 0.15–80 MHz	Compliant	
ISM frequency bands 0.15–80 MHz 80% AM at 1 kHz		
N/A = not applicable		

4.2 Type plate

The type plates are located on the cover of the motor.

EN

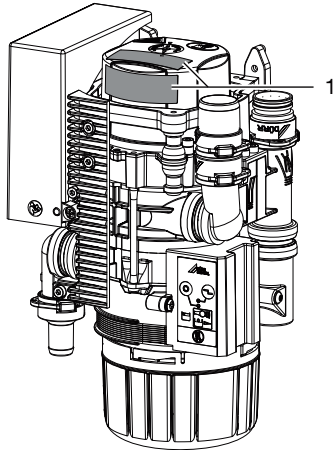

1 Type plate

4.3 Evaluation of conformity

This device has been subjected to conformity acceptance testing in accordance with the current relevant European Union guidelines. This equipment conforms to all relevant requirements.

4.4 Approvals

**Centre of Competence in Civil Engineering,
Berlin**

Test number Z-64.1-20

Separation method compliant with standard

ISO 11143 Type 1

5 Operation

EN

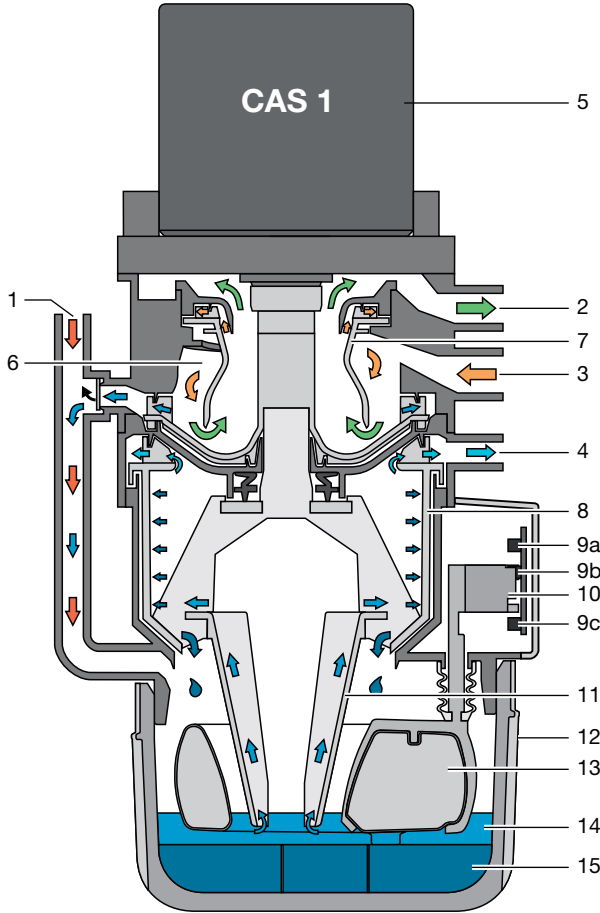

- 1 Fluid intake
- 2 Vacuum, to suction unit
- 3 Aspiration input
- 4 Fluid output
- 5 Motor
- 6 Separation
- 7 Separation rotor
- 8 Centrifuge
- 9 Light barriers (3x)
- 10 Sensor enclosure
- 11 Cone pump
- 12 Amalgam collector vessel
- 13 Float sensor
- 14 Fluids
- 15 Amalgam particles

5.1 Operation

CAS 1 Combi-Separator

EN

The task of the CAS 1 combi-separator is to provide continuous separation of secretions and air as well as the amalgam separation of all the waste water from the treatment unit.

The waste water flows through the connection (1) from the spittoon directly into the centrifuge (8) and amalgam separation.

During the suction phase the aspirated secretions are separated from the aspirated air in the separation unit (6). The secretions accumulating in the separation unit are continuously transported to the centrifuge (8), where the amalgam particles are then separated.

Underneath the centrifuge is a replaceable amalgam collector vessel (12), into which the separated amalgam particles (15) are rinsed once the centrifuge (8) is switched off. A float sensor (13) checks the level within the collector vessel and sends a signal to the display panel when it needs replacing. In combination with a light barrier (9c), this float sensor also monitors whether a collector vessel is in use.

The compact size of the CAS 1 Combi-Separator allows it to be installed in dental treatment units. This results in short secretion carrying lines. After the centrifuge is switched off, the braking cycle triggers a self-cleaning process. This self-cleaning process also leads to smooth and silent running, as well as providing a separation efficiency of more than 95%, even under heaviest loads.

5.2 Separation

At the inlet connection (3) of the CAS 1, the aspirated fluid/air mix is accelerated and set into a spiral motion in the separation unit (6). The resulting centrifugal forces sling the aspirated particles against the outer wall. The air is continuously separated from the fluid and escapes via the spinning separation rotor (7) to the suction unit. The aspirated air is subject to high centrifugal forces by the separation rotor (7), which is driven by the motor (1), which ensures that no fluid or blood foam can be carried into the suction unit. The spiral motion feeds the separated fluid continuously to the pump wheel, which transports the fluid into the collector vessel. The fluid is transported to the centrifuge (8) via a pump cone (11).

An external station selection valve connects the CAS 1 with the suction unit via the vacuum connection (2).

5.3 Spittoon connections

The waste water from the spittoon flows through a protective strainer on the fluid inlet (1) and into the collector vessel (12). Once sufficient fluid has been collected, the float sensor (13) activates a light barrier (9a) and (9b) via a sensor housing (10) and switches on the motor (1). The fluid is transported to the centrifuge (8) via a pump cone (11).

5.4 Station selection valve / safety valve

The station selection valve has 2 tasks:

1st task:

The station selection valve interrupts the suction flow between the hose manifold and the suction unit. As soon as a suction hose is removed from the hose manifold, a solenoid valve opens the station selection valve and suction flow is enabled.

2nd task:

The station selection valve also acts as a safety valve. If the CAS 1 is over-full or not functioning properly, the system will perform a safety shutdown. This safety shutdown prevents fluids from being drawn into the dry suction pipe.



For single station suction systems, the station selection valve takes over the function of the safety valve.

In various types, a station selection valve is already integrated in the CAS 1. The station selection valve is on the connection (2) of the CAS 1.

5.5 Amalgam separation

The switches in the hose manifold or the light barrier of the sensor system switch on the motor and the associated centrifuge (8).

The fluid containing amalgam particles flows continuously to the collector vessel (12). The fluids ejected by the centrifuge are pumped through the fluid output (4) to the central waste water system.

As soon as no further fluid is fed to the amalgam separator, e.g. when the suction hose is placed back in the hose manifold, the centrifuge drum is switched off after a short delay time. This switch-

off brakes the motor, as a result of which the ring of water, which continues to rotate due to inertia, rinses the separated particles out of the centrifuge (8) downwards into the collector vessel. The separated amalgam particles form a sediment in the replaceable collector vessel. The level of fluid in the collector is regulated by the pump cone so that the risk of fluid escaping when the collector vessel is changed can be avoided.

5.6 Sediment level measurement

The fill level in the collector vessel (12) is checked by a float sensor (13) every time the main power switch is switched on.

The centrifuge motor starts, fluid is transported via the pump cone to the centrifuge drum (8) and provides a constant level of fluid (underside of the cone pump) in the collector vessel. The float sensor sinks. Two light barriers (9a) and (9b) measure the fluid level. Once the level reaches 95% in the collector vessel, this is displayed on the display panel.

5.7 Operating problems

If the unit is not ready for operation due to a fault, this will be indicated on the display panel via illuminated LEDs and an audible signal.

5.8 Service key

On the display panel there is a service key that can be used to switch off the audible signal in the event of a fill level warning or if a fault message is indicated. This button can also be used to start the device manually. To do this, press the button for longer than 2 seconds until the drive motor starts up.

Assembly

EN

6 Requirements

6.1 Installation/setup room

The room chosen for set up must fulfil the following requirements:

- Closed, dry, well-ventilated room
- Should not be a room made for another purpose (e. g. boiler room or wet cell)

6.2 Setup options

CAS 1 Combi-Separator

- Directly in the treatment unit.
- In a special housing in an extension of the treatment unit.

6.3 Hose materials

For waste connections and suction lines only use the following hose types:

- Flexible spiral hoses made of PVC with integrated spiral or equivalent hoses
- Hoses that are resistant to dental disinfectants and chemicals



Plastic hoses will display signs of ageing over time. Therefore, they should be inspected regularly and replaced as necessary.

The following types of hoses must not be used:

- Rubber hoses
- Hoses made completely of PVC
- Hoses that are not sufficiently flexible

6.4 Installation and routing of hoses and pipes

- › Execute the on-site pipe installation in accordance with the applicable local regulations and standards.

- › Lay the hose installation of the drains to or from the unit at a sufficient incline.



If incorrectly laid, the hoses can become blocked with sedimentation.

6.5 Information about electrical connections

- › Ensure that electrical connections to the mains power supply are carried out in accordance with current valid national and local regulations and standards governing the installation of low voltage units in medical facilities.
- › Install an all-pole disconnect switch with a contact opening width of at least 3 mm in the electrical connection to the mains power supply.
- › Observe the current consumption of the devices that are to be connected.
- › Install electrical lines without mechanical tension.
- › Make the electrical connection via the main power switch of the treatment unit or via the main power switch of the practice.

6.6 Information about connecting cables

Mains supply cable

Installation type	Line layout (minimum requirements)
Fixed installation	– Plastic sheathed cable (e.g. type NYM-J)
Flexible	– PVC flexible line (e.g. H05 VV-F) or – Rubber connection (e.g. H05 RN-F or H05 RR-F)

Control cable

Installation type	Line layout (minimum requirements)
Fixed installation	– Shielded sheathed cable (e.g. (N)YM (St)-J)

Installation type	Line layout (minimum requirements)
Flexible	<ul style="list-style-type: none"> – PVC data cable with shielded cable sheathing, as used for telecommunications and IT processing systems (e.g. type LiYCY) or <ul style="list-style-type: none"> – Lightweight PVC control cable with shielded cable sheathing

Wire cross-section

- Unit feed:
 - 0.75 mm²
- Connection external valves / units:
 - 0.5 mm²

7 Installation



Prior to working on the unit or in case of danger, disconnect it from the mains.

EN

7.1 Combining devices safely

Take care when connecting units together or to parts of other systems as there is always an element of risk (e.g. due to leakage currents).

- › Only connect units when there can be no question of danger to operator or to patient.
- › Only connect units when it is safe to do so and when there is no risk of damage or harm to the surroundings.
- › If it is not 100% clear from the unit data sheet that such connections can be safely made or if you are in any doubt, always get a suitably qualified person (e.g. the manufacturer) to verify that the setup is safe.

7.2 Installation of the CAS 1 in treatment units

The CAS 1 Combi Separator for KaVo treatment units must be set up in a defined installation setup in order to meet the relevant safety standards. For this reason it must only be installed in the treatment units that have been designed and approved for this purpose by KaVo.

KaVo-approved treatment units:

New units delivered from 01/2016 onwards: E50, E50 Life, E70/E80, E70/E80 Vision, 1058, 1058 Life

Spare parts requirements for old units such as 1078 and 1080 among others.



WARNING

Infection due to contaminated unit

- › Clean and disinfect the suction before working on the unit.
- › Wear protective equipment when working (e. g. impermeable gloves, protective goggles and mouth and nose protection).

Attach the unit vertically at a suitable position in the treatment unit. The unit is mounted on rubber pads and suspended in a metal frame. This mounting arrangement prevents the transmission of any vibrations to the treatment unit while the

device is running. Vibrations may occur if the unit is not positioned vertically. A minimum distance of 3 mm must be maintained to the surroundings.

EN

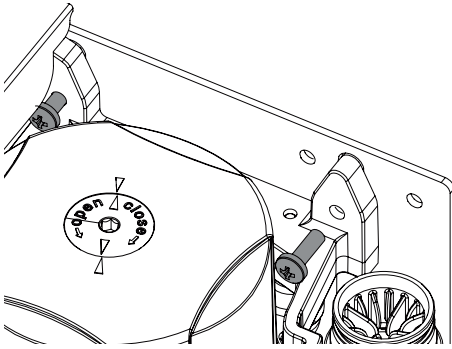

Station selection valve

In various types, the station selection valve is directly mounted on the CAS 1. The station selection valve (for separate installation) should be fitted in the suction pipe in the treatment unit, preferably near the end connection in the floor socket. In some installation setups the station selection valve also functions as a safety valve, so its actuation must be implemented via the CAS 1.

For further information, refer to the station selection valve installation and operating instructions

Inlet and outlet hoses

Connect and attach the inlet and outlet hoses with DürrConnect connectors to the relevant connections on the unit. Route the hoses at an incline.

Recommended diameter of the connection hoses: \varnothing 25 mm.

The minimum nominal width for the outlet hose is 15 mm.

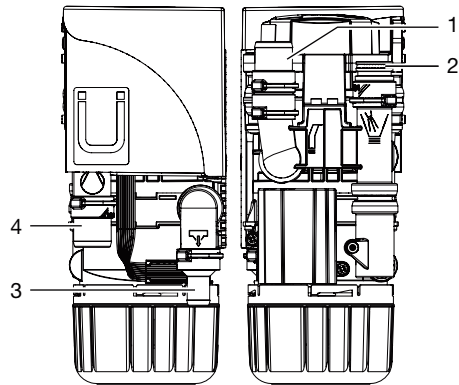

- 1 Hose manifold
- 2 Spittoon
- 3 Outlet
- 4 Suction unit

Spittoon connections

In some dental units it is possible that noises can be heard at the spittoon, which are amplified by the funnel shape of the spittoon itself. In this case, the outlet between spittoon and CAS 1 should be bled. A corresponding siphon trap with ventilation is available as a special accessory.

Rinsing unit

It is recommended that the suction system is equipped with a rinsing unit, e.g. in the treatment unit. The rinsing unit provides a small amount of water during aspiration. This dilutes the aspirated fluids (blood, saliva, rinsing water etc.), which can then be transported more effectively.

7.3 Electrical connections, controller

Power supply:

- Safety transformer order number: 9000-150-46

or

- Safety transformer 24 V AC with a with an isolator consisting of two means of patient protection (MOPP) between the mains circuit and secondary circuit, min. 100 VA, secondary fuse T 4 AH (or IEC 60127-2/V T 4 AH, 250 V)

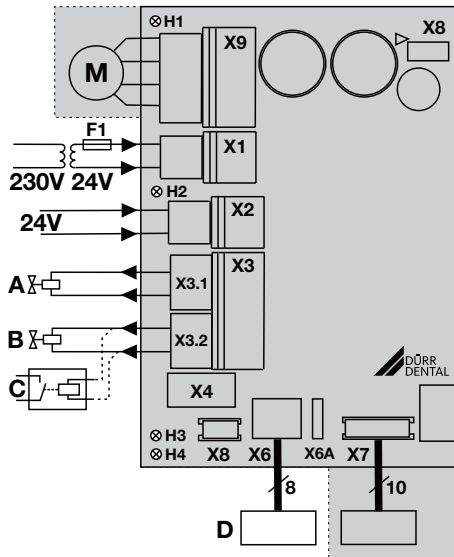

- X1 Power supply in accordance with EN 60601-1, 24 V AC
- X2 Signal input 24 V AC/DC
- X3.1 Place selection valve / safety valve (only CAS 1, max. output 8 W)
- X3.2 Rinsing unit (CAS 1 only)
- X4 CAN bus
- X6 Display panel, external (X6A = connection for predecessor model)
- X7 Sensor technology
- X8 Production interface
- X9 Motor
- H1 Motor control display
- H2 Manifold control display
- H3 Place selection valve control display
- H4 Control display, collecting container missing
- A Place selection valve
- B Rinsing unit
- C Suction unit relay (alternative)
- D Display panel, external

7.4 Electrical connections

Station selection valve / safety valve

- › Connect the station selection valve / safety valve using a 2-core wire with connector to the X3 connection of the control.

Rinsing unit

- › Connect the rinsing unit using a 2-core wire with connector to the X3 connection of the control.



At the connection for the rinsing unit, a suction unit relay, for example, can be connected if there is no isolation present between the suction unit signal and station selection valve in the treatment unit. Note the power consumption of the suction unit relay.

EN

Display panel



The display panel is used to indicate messages acoustically and visually (via LEDs).

A display panel is already integrated in the unit and should be visible/audible at all times.

If the display panel is not visible/audible, fit an additional display panel in an easily visible location. The display panel is connected to the X6 socket (RJ-45 socket). An existing Dürr Dental display panel with a 6-pin connector can be connected to the X6A connector when replacing an older device.

If the installation of the amalgam separator in a neighbouring room or in the basement results in distances of more than 3 m, we recommend installing a shielded network cable with RJ-45 sockets.

8 Commissioning

EN



In many countries technical medical products and electrical devices are subject to regular checks at set intervals. The owner must be instructed accordingly.

- › Turn on the unit power switch or the main surgery switch.
- › Carry out an electrical safety check in accordance with applicable local regulations (e.g. the German Ordinance on the Installation, Operation and Use of Medical Devices / Medizinprodukte-Betreiberverordnung) and record the results as appropriate, e.g. in the technical log book.
- › Check the aspiration function.
- › Check the start function via the spittoon.
- › Check the connections, hoses and device for leaks.

9 Service program

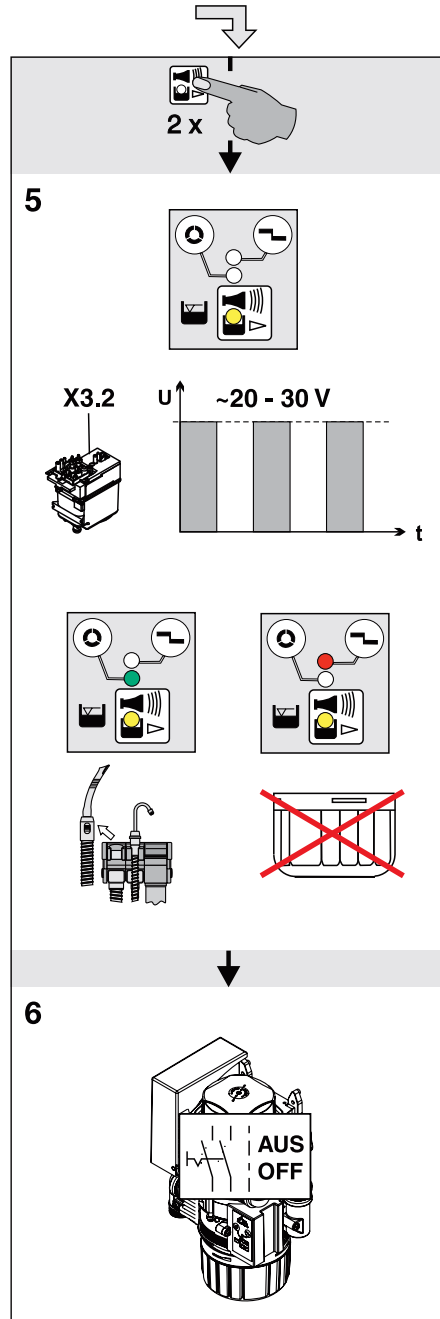
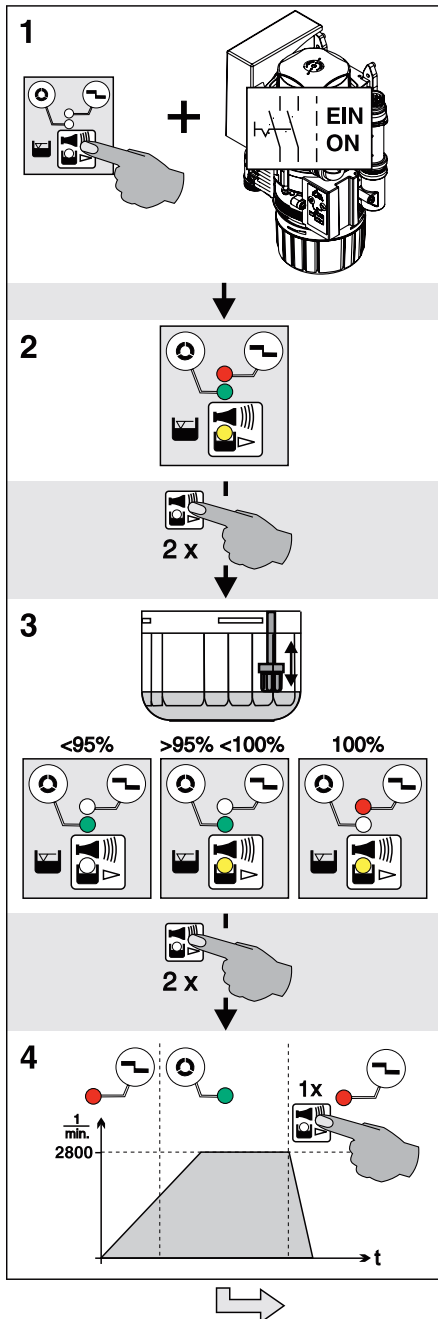

EN

10 Description of the service program

EN



Wear protective equipment to avoid any risk of infection (e.g. liquid-tight protective gloves, protective goggles, face mask).

The various unit functions can be checked with the aid of the service program.

The individual program steps are:

- Display test
- Sediment level measurement
- Motor start and motor braking with rpm check
- Input and output signals

Function of the service key:

- By pressing the service key twice the next individual program step is called up.
- By pressing the service key once that program step is repeated.

A press of the service key is confirmed by an audible signal.

10.1 Service program ON/OFF

On

- Press the service key and switch on the voltage supply to the unit.
- As soon as a signal melody can be heard, release the service key.
The green, yellow and orange LEDs on the display panel light up (display test) and the service program is activated.

Off

Switch off the main supply to the unit.

10.2 Display test

The display test is activated as soon as the service program is started.

The LEDs on the display panel are checked. All three LEDs must come on. There is also an audible signal, which can be switched off by pressing the service button.

10.3 Sediment level measurement



While the service program is activated, the safety check for the collector vessel is deactivated.

The sediment level measurement can be used to check the function of the sediment sensor and the function of the LEDs.

Every time the service key is pressed, the sediment level is checked. If a test collector vessel is used for this, the different levels can be scanned and made visible on the display panel.

While changing the collectors (collector vessel - test collector vessel) in the service program the unit remains in the ON state.

10.4 Motor start - motor braking

The drive motor starts and, after approx. 5 seconds, braking is applied. If the service key is pressed during these 5 seconds, the motor will immediately be braked.

This procedure can be repeated by pressing the service key 1x again.

The drive motor starts up.

As a result of the rpm monitoring, the LED will change from orange to green upon start-up and from green to orange upon braking.

10.5 Input and output signals

- After this program item is activated, the yellow LED flashes and a cycled DC voltage (approx. 22-30 V) can be measured at the terminal for the rinsing unit.
- If the suction hose is lifted off the hose manifold the green LED will also come on.
- Removal of the collecting container causes the red LED to illuminate.

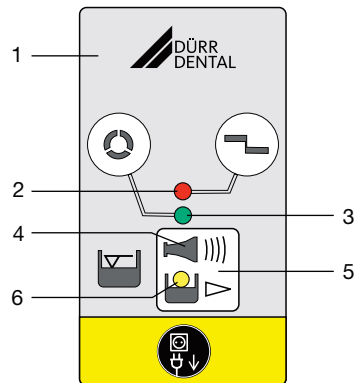

 Usage**11 Display/handling**

- 1 Display panel
- 2 RED display
- 3 GREEN LED
- 4 Audible signal/melody
- 5 Reset/service key
- 6 YELLOW LED

11.1 Ready for operation

-  Green LED is on



11.2 Amalgam collector vessel is 95% full

-  Yellow LED is on
-  Green LED is on
-  Audible signal melody sounds

- At a fill level of 95%, the signal melody can be switched off by pressing the reset button. The device is then ready for operation again.
- The yellow LED comes on as a reminder that the amalgam collector vessel is due to be changed. The level display is repeated every time the unit is switched on at the main power switch.

 We recommend changing the amalgam collector vessel when it reaches 95% full.

11.3 Amalgam collector vessel is 100% full



-  Yellow LED is on
-  Red display flashes
-  Audible signal melody sounds

- At a fill level of 100% the signal melody can no longer be switched off by pressing the reset button.
- The collecting container needs to be replaced.

 Wear protective equipment to avoid any risk of infection (e.g. liquid-tight protective gloves, protective goggles, face mask).

- The separator will not be ready for operation again until the amalgam collecting container has been replaced



11.4 Amalgam collector vessel not in position

-  Red display flashes
-  Audible signal

- Press the reset button briefly to switch off the audible signal.
- Switch off the device.
- Insert the collecting container.
- Switch on the unit.
- Green LED lights up – "Ready for operation"

 If this error message occurs when the collecting container is correctly inserted, this indicates that there is a technical defect – inform your Service Technician.

11.5 Motor fault

-  Red display and
-  green LED flash alternately
-  Audible signal

- Press the reset button briefly to switch off the audible signal.
- If the reset button is pressed for longer than 2 seconds the unit can be restarted.
- Green LED lights up – "Ready for operation"

EN

 If, after pressing the reset button repeatedly, the fault report reappears again each time, this indicates a technical defect – inform your Service Technician.

12 Disinfection and cleaning



NOTICE

Device malfunctions or damage due to use of incorrect media

Guarantee claims may become invalid as a result.

- › Do not use any foaming agents such as household cleaning agents or instrument disinfectants.
- › Do not use abrasive cleaners.
- › Do not use agents containing chlorine.
- › Do not use any solvents like acetone.

Dürr Dental recommends

- For disinfection and cleaning:
Orotol plus or Orotol ultra
- For cleaning:
MD 555 cleaner

Only these products have been tested by Dürr Dental.

When using prophylaxis powders, Dürr Dental recommends the water-soluble Lunos prophylaxis powders in order to protect the Dürr Dental suction systems.

12.1 After every treatment

- › Aspirate a glass of cold water through the large and the small suction hoses. Do this even if only the small suction hose was actually used during treatment.



Suction through the large suction hose causes a large amount of air to be drawn up, thereby considerably increasing the cleaning effect.

12.2 Daily after the end of treatment



After higher workloads before the midday break and in the evening

The following are required for disinfection/cleaning:

- ✓ Non-foaming disinfectant/cleaning agent that is compatible with the materials.
- ✓ Unit care system, e.g. OroCup
- › To pre-clean, suck up 2 litres of water with the care system.
- › Aspirate the disinfection/cleaning agent with the care system.

12.3 Once or twice a week before the midday break



Under harsher conditions (e.g. hard water or frequent use of prophylactic powders) 1x daily before the midday break

The following are required for cleaning:

- ✓ Special non-foaming detergent for suction units that is compatible with the materials.
- ✓ Unit care system, e.g. OroCup
- › To pre-clean, suck up 2 litres of water with the care system.
- › Aspirate the cleaning agent with the care system.
- › Rinse with ca. 2 l water after the application time.

13 Replace the amalgam collector vessel



NOTICE

Risk of contamination if the amalgam collector vessel is reused since the collector vessel is not water-tight.

- › Do not use the collecting container more than once (disposable item).

EN



Wear protective equipment to avoid any risk of infection (e.g. liquid-tight protective gloves, protective goggles, face mask).



We strongly recommend that the amalgam collecting container should only be changed in the morning before the start of work. This will prevent fluid from dripping out of the drum while it is being changed.

- › Disconnect all power from the unit.
- › Remove the full amalgam collecting container and from the device.
- › Pour disinfectant for suction units (e. g. Orotol plus, 30 ml) into the full amalgam collecting container.
- › Close and secure the full amalgam collecting container using the cap. Observe the markings on the cap and on the collecting container.
- › Place the securely closed amalgam collecting container into its original packaging and seal.
- › Insert a new amalgam collecting container in the unit and clamp it in position.



Only use original amalgam collecting container.

- › Switch on the power supply. The unit is ready for operation again.

13.1 Disposal of the collector vessel



Used amalgam collector vessels must not be sent in the post!



Dürr Dental is not a waste management company and is not allowed by law to accept any filled amalgam collector vessels.

› Arrange to have filled amalgam collector vessels collected from the surgery by a local waste management company.

EN

› New amalgam collector vessels should be ordered from your specialist dental equipment retailer.

› Document the replacement and legally compliant disposal of the filled waste amalgam collector vessel in the Operating Handbook.



In some countries the owner is required to keep an operating handbook. This operating handbook must document all maintenance work, service work, checks and amalgam disposal.

14 Maintenance



All maintenance work must be performed by a qualified expert or by one of our Service Technicians.

EN



WARNING

Infection due to contaminated unit

- › Clean and disinfect the suction before working on the unit.
- › Wear protective equipment when working (e. g. impermeable gloves, protective goggles and mouth and nose protection).



Prior to working on the unit or in case of danger, disconnect it from the mains.

Maintenance interval	Maintenance work
Dependent upon the level of usage of the device	<ul style="list-style-type: none"> › Replace the amalgam collecting container when a fill level of 95% or 100% is indicated on the display panel › Clean or replace protective sieves during replacement of the amalgam collecting container. At the latest, do this when the suction or draining power of the device decreases.
Annually	<ul style="list-style-type: none"> › Cleaning of the suction unit in accordance with the operating instructions. › Clean the float. * › Replace the bellows. *
Every 3 years	<ul style="list-style-type: none"> › Replace the rubber grommets on the connections. * › Replace the float. *
Every 5 years	<ul style="list-style-type: none"> › Replace the centrifuge drum and seal. * › Replace all O-rings (from the replacement parts kit) in the device. * › Replace the rubber grommets on the connections. * › Replace the float. *

* to be done by service technicians only

14.1 Tests

EN



WARNING

Infection due to contaminated unit

- › Clean and disinfect the suction before working on the unit.
- › Wear protective equipment when working (e. g. impermeable gloves, protective goggles and mouth and nose protection).



In some countries the owner is required to keep an operating handbook. This operating handbook must document all maintenance work, service work, checks and amalgam disposal.

Annual inspection

This inspection should only be carried out by suitably trained staff.

For inspection, the following are required:

- ✓ Test vessel

Work steps to be performed:

- › General functional check (e.g. aspiration, spittoon inlet)
- › Service program

The following measurement times apply to fill level measurements with a test vessel:

- For a fill level of 95%, the measurement result is displayed after approx. 30 sec, whereby the drive motor is briefly switched off during the measurement.
- At a fill level of 100% the measurement result is displayed after approx. 90 sec continuous running.

Inspection of the general operating condition every 5 years

This inspection must be carried out every 5 years (in accordance with the German Waste Water Regulations, Annex 50, Dental Treatment) by an inspector in accordance with national regulations.

For inspection, the following are required:

- ✓ Test vessel
- ✓ Measuring beaker

Work steps to be performed:

- › Fill the test vessel with water and insert it into the unit.
- › Start the device and wait until it switches off again.

- › Once the device has switched off, remove the test vessel and measure the remaining amount of water.

The unit is working correctly if:

- there is at minimum content of 140 ml in the **test vessel**.

If there is less fluid, clean the centrifuge drum or check the operation of the unit.

? Troubleshooting

15 Tips for operators and service technicians

EN

 Any repairs exceeding routine maintenance may only be carried out by qualified personnel or our service.

 **WARNING**
Infection due to contaminated unit

- › Clean and disinfect the suction before working on the unit.
- › Wear protective equipment when working (e. g. impermeable gloves, protective goggles and mouth and nose protection).

 Prior to working on the unit or in case of danger, disconnect it from the mains.

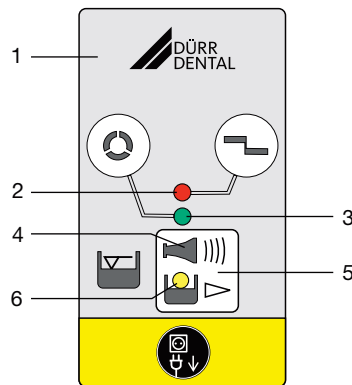

- 1 Display panel
- 2 RED display
- 3 GREEN LED
- 4 Audible signal/melody
- 5 Reset/service key
- 6 YELLOW LED

Error	Possible cause	Remedy
Device not "ready for operation" No display on the display panel.	The main power switch of the treatment unit or surgery is not switched on	› Main power switch ON
	If an external display panel is fitted: cable not correctly connected	› Check cable connections

? Troubleshooting

EN

Error	Possible cause	Remedy
Yellow display is on GREEN LED illuminates Audible signal melody sounds	Amalgam collecting container is 95% full	› Change the amalgam collecting container.
	Float sensor dirty or blocked	› If this display occurs repeatedly even when the collecting container is empty, check that the float sensor can move freely.
Yellow display is on Red display flashes Audible signal melody sounds	Amalgam collecting container is 100% full	› Change the amalgam collecting container. Audible signal can no longer be switched off.
	Float sensor dirty or blocked	› If this display occurs repeatedly even when the collecting container is empty, check that the float sensor can move freely.
	Waster water line/siphon trap dirty	› Clean the waste water line/siphon trap. *
The RED and GREEN displays flash alternately Audible signal	Motor is dirty or defective	› Check motor for smooth running; replace the centrifuge if necessary. * › Replace the device. *
	Contact problems at X9	› Plug in the connector correctly. * › Replace the PCB main board and connector on the motor. *
Orange LED flashes Audible signal		Press the service key briefly to switch off the audible signal
	Amalgam collecting container not correctly in position	› Switch OFF the device. › Insert the amalgam collecting container in the correct position. › Switch ON the device.
	Float sensor missing	› Insert the float sensor. *
Water accumulating in the spittoon	Coarse sieve in the fluid inlet blocked	› Clean the coarse sieve.
	Outlet ineffective or not vented	› Check or retrofit the ventilation. *
Suction power too weak or interrupted	Coarse sieve is blocked on the inlet of the aspiration	› Clean the coarse sieve.
	Place selection valve not or incompletely open	› Check the control voltage. * › Clean the place selection valve. *

Error	Possible cause	Remedy
Device running continuously	Float sensor blocked in water start position	<ul style="list-style-type: none"> › Clean the float. * › Free up the float sensor linkage so that it can move freely. *
	Start signal at the signal input (X2)	› Check the control voltage. *
	Waster water line/siphon trap dirty	› Clean the waste water line/siphon trap. *
Noise at the spittoon	Outlet ineffective or not vented	› Check or retrofit the ventilation. *
Increased vibration of the device	Pump cone dirty	› Clean or replace the pump cone. *
	Centrifuge dirty	› Clean or replace the centrifuge. *
	Water supply too low	<ul style="list-style-type: none"> › Introduce water into the suction pipe. › Retrofit the rinsing unit. * › Check the rinsing unit for its correct installation position. * › Check the function of the rinsing unit. *
Water cannot be pumped away or only insufficiently	Centrifuge dirty	› Clean or replace the centrifuge
	Waster water line/siphon trap dirty	› Clean the waste water line/siphon trap

EN

* Only to be done by service technicians.

16 Transporting the unit

EN



WARNING

Infection due to contaminated unit

- › Disinfect the unit before transport.
- › Close all media connections.



Wear protective equipment to avoid any risk of infection (e.g. liquid-tight protective gloves, protective goggles, face mask).

- › Before disassembly, clean and disinfect the suction unit and the unit using a suitable disinfectant approved by Dürr Dental.
- › Disinfect a defective unit using a suitable surface disinfection agent.
- › Seal all connections with sealing caps.
- › Pack the unit securely in preparation for transport.

16.1 Close CAS 1

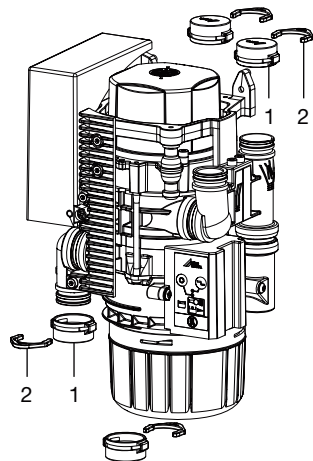

- 1 Dummy bushing
- 2 Ring clamp

 Appendix

EN

17 Handover record

This document confirms that a qualified handover of the medical device has taken place and that appropriate instructions have been provided for it. This must be carried out by a qualified adviser for the medical device, who will instruct you in the proper handling and operation of the medical device.

Product name	Order number (REF)	Serial number (SN)

- Visual inspection of the packaging for any damage
- Unpacking the medical device and checking for damage
- Confirmation of the completeness of the delivery
- Instruction in the proper handling and operation of the medical device based on the operating instructions

Notes:

Name of person receiving instruction:**Signature:**

Name and address of the qualified adviser for the medical device:

Date of handover:**Signature of the qualified adviser for the medical device:**

--	--



Hersteller/Manufacturer:

DÜRR DENTAL SE
Höpfigheimer Str. 17
74321 Bietigheim-Bissingen
Germany
Fon: +49 7142 705-0
www.duerrdental.com
info@duerrdental.com



CS 1 Combi-Sepamatic 24 V AC

EN

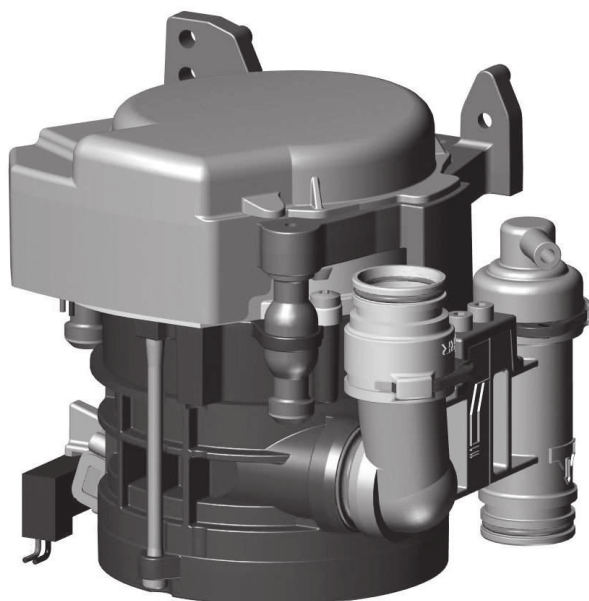

Installation and operating instructions

CE

9000-606-39/30



 **DÜRR
DENTAL** 2103V007

Contents



Important information

1 About this document	2
1.1 Warnings and symbols	2
1.2 Copyright information	3
2 Safety	3
2.1 Intended purpose	3
2.2 Intended use	3
2.3 Improper use	3
2.4 General safety information	4
2.5 Combining devices safely	4
2.6 Specialist personnel	4
2.7 Notification requirement of serious incidents	4
2.8 Electrical safety	4
2.9 Only use original parts	5
2.10 Transport	5
2.11 Disposal	5



Product description

3 Overview	6
3.1 Scope of delivery	6
3.2 Optional items	6
3.3 Consumables	6
3.4 Wear parts and replacement parts	6
4 Technical data	7
4.1 Type plate	11
4.2 Evaluation of conformity	11
5 Operation	12
5.1 Separation	12
5.2 Station selection valve	12



Assembly

6 Requirements	13
6.1 Setup options	13

6.2 Hose materials	13
6.3 Installation and routing of hoses and pipes	13
6.4 Information about electrical connections	13
6.5 Information about connecting cables	13
7 Installation	14
7.1 Installation of the CS 1 in treatment units	14
7.2 Power supply	15
7.3 Electrical connections, controller	15
7.4 Electrical connections	15
8 Commissioning	16

EN



Usage

9 Disinfection and cleaning	17
9.1 After every treatment	17
9.2 Daily after the end of treatment	17
9.3 Once or twice a week before the midday break	17
10 Maintenance	18



Troubleshooting

11 Tips for operators and service technicians	19
11.1 Replacing the fuse	20
12 Transporting the unit	20
12.1 Close the CS 1	20



Appendix

13 Handover record	21
-------------------------------------	----

! Important information

EN

1 About this document

These installation and operating instructions represent part of the unit.

 If the instructions and information in these installation and operating instructions are not followed, Dürr Dental will not be able to offer any warranty or assume any liability for the safe operation and the safe functioning of the unit.

The German version of the installation and operating instructions is the original manual. All other languages are translation of the original manual. These installation and operating instructions apply to:

CS 1
7117-100-70; 7117-100-70E; 7117-100-74;
7117-100-74E; 7117-100-76; 7117-100-77;
7117-100-78; 7117-100-79; 7117-100-80;
7117-100-80E

1.1 Warnings and symbols

Warnings

The warnings in this document are intended to draw your attention to possible injury to persons or damage to machinery.

The following warning symbols are used:

 General warning symbol

 Biohazard warning

The warnings are structured as follows:

 **SIGNAL WORD**
Description of the type and source of danger

Here you will find the possible consequences of ignoring the warning

› Follow these measures to avoid the danger.

The signal word differentiates between four levels of danger:

- **DANGER**
Immediate danger of severe injury or death
- **WARNING**
Possible danger of severe injury or death
- **CAUTION**
Risk of minor injuries
- **NOTICE**
Risk of extensive material/property damage

Other symbols

These symbols are used in the document and on or in the unit:

 Note, e.g. specific instructions regarding efficient and cost-effective use of the unit.

 Refer to Operating Instructions.

 Wear protective gloves.

 Disconnect all power from the unit.

 Hose manifold connection

 Suction unit connection

 Drain connection

 **REF** Order number

 **SN** Serial number

 **MD** Medical device

 **HIBC** Health Industry Bar Code (HIBC)

 **CE** CE labelling

 **II** Protection class II

 **Manufacturer**

1.2 Copyright information

All circuits, processes, names, software programs and units mentioned in this document are protected by copyright.

The Installation and Operating Instructions must not be copied or reprinted, neither in full nor in part, without written authorisation from Dürr Dental.

2 Safety

Dürr Dental has designed and constructed this unit so that when used properly and for the intended purpose it does not pose any danger to people or property.

Despite this, the following residual risks can remain:

- Personal injury due to incorrect use/misuse
- Personal injury due to mechanical effects
- Personal injury due to electric shock
- Personal injury due to radiation
- Personal injury due to fire
- Personal injury due to thermal effects on skin
- Personal injury due to lack of hygiene, e.g. infection

2.1 Intended purpose

The separation system is designed for the continuous separation of air and liquids in the suction flow of dental treatment units.

2.2 Intended use

The separation system is intended for installation in the suction line of a dry suction system after the manifold.

Service, maintenance, recurring tests and cleaning must be performed in accordance with the manufacturer's information.

The permissible flow rate must be observed.

A rinsing unit is required for surgical procedures and for procedures using prophylaxis powders.

2.3 Improper use

Any use of this appliance / these appliances above and beyond that described in the Installation and Operating Instructions is deemed to be incorrect usage. The manufacturer cannot be held liable for any damage resulting from incorrect usage. The operator will be held liable and bears all risks.

This includes:

EN

! Important information

EN

- Use for separation of dust, sludge, plaster or similar.
- Use in conjunction with flammable or explosive mixtures.
- Installation in a manner that does not comply with the installation instructions, in particular installation in rooms containing a potentially explosive atmosphere.
- Cleaning and disinfection with agents containing sodium hypochlorite or potassium hypochlorite.

2.4 General safety information

- › Always comply with the specifications of all guidelines, laws, and other rules and regulations applicable at the site of operation for the operation of this unit.
- › Check the function and condition of the unit prior to every use.
- › Do not convert or modify the unit.
- › Comply with the specifications of the Installation and Operating Instructions.
- › The Installation and Operating Instructions must be accessible to all operators of the unit at all times.

2.5 Combining devices safely

Take care when connecting units together or to parts of other systems as there is always an element of risk (e.g. due to leakage currents).

- › Only connect units when there can be no question of danger to operator or to patient.
- › Only connect units when it is safe to do so and when there is no risk of damage or harm to the surroundings.
- › If it is not 100% clear from the unit data sheet that such connections can be safely made or if you are in any doubt, always get a suitably qualified person (e.g. the manufacturer) to verify that the setup is safe.

Where applicable, the requirements for medical products have been taken into account in the development and construction of the device. As a result, this device is suitable for installation within medical supply equipment.

- › Where this device is integrated in other medical supply equipment, the requirements of European Union Medical Device Regulation 2017/745 and the relevant standards must be observed.

2.6 Specialist personnel

Operation

Unit operating personnel must ensure safe and correct handling based on their training and knowledge.

- › Instruct or have every user instructed in handling the unit.

Installation and repairs

- › Installation, readjustments, alterations, upgrades and repairs must be carried out by Dürr Dental or by qualified personnel specifically approved and authorized by Dürr Dental.

2.7 Notification requirement of serious incidents

The operator/patient is required to report any serious incident that occurs in connection with the device to the manufacturer and to the competent authority of the Member State in which the operator and/or patient is established/resident.

2.8 Electrical safety

- › Comply with all the relevant electrical safety regulations when working on the unit.
- › Never touch the patient and unshielded plug connections on the device at the same time.
- › Replace any damaged cables or plugs immediately.

Observe the EMC rules concerning medical devices

- › The unit is intended for use in professional healthcare facilities (in accordance with IEC 60601-1-2). If the appliance is operated in another environment, potential effects on electromagnetic compatibility must be taken into account.
- › Do not operate the unit in the vicinity of HF surgical instruments or MRT equipment.
- › Keep a minimum distance of 30 cm between the unit and mobile radio devices.
- › Note that cable lengths and cable extensions have effects on electromagnetic compatibility.

**NOTICE****Negative effects on the EMC due to non-authorised accessories**

- › Use only Dürr Dental parts or accessories specifically approved by Dürr Dental.
- › Using any other accessories may result in increased electromagnetic interference emissions or the unit having reduced electromagnetic immunity, leading to an erroneous operation mode.

**NOTICE****Erroneous operation mode due to use immediately adjacent to other devices or with other stacked devices**

- › Do not stack the unit together with other devices.
- › If this is unavoidable, the unit and other devices should be monitored in order to ensure that they are working correctly.

2.9 Only use original parts

- › Only use accessories and optional items that have been recommended or specifically approved by Dürr Dental.
- › Only use only original wear parts and replacement parts.



DÜRR MEDICAL accepts no liability for damages or injury resulting from the use of non-approved accessories or optional accessories, or from the use of non-original wear parts or replacement parts. The use of non-approved accessories, optional accessories or non-genuine wear parts / replacement parts (e.g. mains cables) can have a negative effect in terms of electrical safety and EMC.

2.10 Transport

The original packaging provides optimum protection for the unit during transport. If required, original packaging for the unit can be ordered from Dürr Dental.



Dürr Dental will not accept any responsibility or liability for damage occurring during transport due to the use of incorrect packaging, even where the unit is still under guarantee.

- › Only transport the unit in its original packaging.
- › Keep the packing materials out of the reach of children.

2.11 Disposal

The unit may be contaminated. Instruct the company disposing of the waste to take the relevant safety precautions.

- › Decontaminate potentially contaminated parts before disposing of them.
- › Uncontaminated parts (e.g. electronics, plastic and metal parts etc.) should be disposed of in accordance with the local waste disposal regulations.
- › If you have any questions about the correct disposal of parts, please contact your dental trade supplier.



An overview of the waste keys for Dürr Dental products can be found in the download area at:
www.duerrdental.com
Document no.: P007100155

EN

Product description

EN

3 Overview

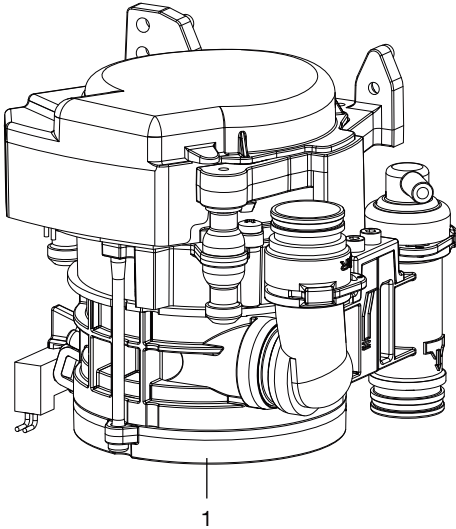

1 CS 1 Combi-Sepamatic

3.1 Scope of delivery

The scope of delivery can vary slightly depending on the version.

The following items are included in the scope of delivery:

- CS 1 7117-100-7x
- or
- CS 1 7117-100-8x
- Combi-Sepamatic
- or Combi-Sepamatic inc. station selection valve
- Rinsing unit
- Installation and Operating Instructions

3.2 Optional items

The following optional items can be used with the device:

- Various installation sets are available on request
- Safety transformer 24 V, 100 VA .. 9000-150-46
- Station selection valve for CAS 1 /
- CS 1 7560-500-80
- Station selection valve 7560-500-60
- Vario rinsing unit 7100-260-51
- Rinsing unit II 7100-250-50
- OroCup care system 0780-350-00

3.3 Consumables

The following materials are consumed during operation of the device and must be ordered separately:

- DürrConnect protective strainer,
- 5 pieces 0700-700-18E
- Orotol plus (2.5 litre bottle) CDS110P6150
- MD 550 spittoon bowl cleaner
- (750 ml bottle) CCS550C4500
- MD 555 cleaner (2.5 litre bottle) CCS555C6150

3.4 Wear parts and replacement parts

The following working parts need to be changed at regular intervals (refer to the "Maintenance" section):

- Protective strainer
- Rubber grommets
- O-rings

Replacement parts set (3 years) .. 7117-980-33

O-ring set for CS 1 7117-980-22

Information about replacement parts is available from the portal for authorised specialist dealers at: www.duerrdental.net

4 Technical data

Electrical data – centrifuge motor		7117-100-7x 7117-100-8x
Rated voltage	V	24 AC
Frequency	Hz	50 / 60
Rated power	VA	70
Nominal current in standby	mA	80
Signal input from the hose manifold	V	24 AC
	Hz	50/60
Signal output	V	24 DC
	mA	300
Media		
Fluid volume		
min.	l/min	≥ 0.1
max.	l/min	≤ 2.0
Air flow volume	l/min	≤ 350
Flow rate		high
The suction system must be suitable for a high flow rate in accordance with EN ISO 10637.		
Max. pressure	hPa/mbar	-160
General data		
Operating mode	%	100 (S1)
Type of protection		IP 20
Protection class		II
Noise level, approx.*	dB(A)	45
Dimensions (H x W x D)	cm	15 x 16 x 12
Weight, approx.	kg	1.4
* in accordance with EN ISO 3746		
Ambient conditions during storage and transport		
Temperature	°C	-10 to +60
Relative humidity	%	< 95
Ambient conditions during operation		
Temperature	°C	+10 to +40
Relative humidity	%	< 70
Classification		
Medical Device Class		I

EN

Electromagnetic compatibility (EMC)		
Interference emission measurements		
EN	High-frequency emissions in accordance with CISPR 11	Group 1 Class B
	Interference voltage at the power supply connection CISPR 11:2009+A1:2010	Compliant
	Electromagnetic interference radiation CISPR 11:2009+A1:2010	Compliant
	Emission of harmonics IEC 61000-3-2:2005+A1:2008+A2:2009	N/A
	Voltage changes, voltage fluctuations and flicker emissions IEC 61000-3-3:2013	N/A
	N/A = not applicable	
Electromagnetic compatibility (EMC)		
Interference immunity measurements		
	Immunity to electrostatic discharge IEC 61000-4-2:2008	Compliant
	Immunity to high-frequency electromagnetic fields IEC 61000-4-3:2006+A1:2007+A2:2010	Compliant
	Immunity to near fields of wireless HF communication devices IEC 61000-4-3:2006+A1:2007+A2:2010	Compliant
	Immunity to fast electrical transients/bursts – AC mains voltage IEC 61000-4-4:2012	Compliant
	Immunity to electrical fast transients/bursts – I/O, SIP/SOP ports IEC 61000-4-4:2012	Compliant
	Immunity to interference, surges IEC 61000-4-5:2005	Compliant
	Immunity to conducted disturbances, induced by radio-frequency fields – AC mains voltage IEC 61000-4-6:2013	Compliant
	Immunity to conducted disturbances, induced by radio-frequency fields – SIP/SOP ports IEC 61000-4-6:2013	Compliant
	Immunity to power frequency magnetic fields IEC 61000-4-8:2009	Compliant
	Immunity to voltage dips, short interruptions and voltage variations IEC 61000-4-11:2004	Compliant

Electromagnetic compatibility (EMC)		
Interference immunity measurements on the supply input		
Immunity to fast electrical transients/bursts – AC mains voltage IEC 61000-4-4:2012 ± 2 kV 100 kHz repetition rate	Compliant	EN
Immunity to surges, line-to-line IEC 61000-4-5:2005 ± 0.5 kV, ± 1 kV	Compliant	
Immunity to conducted disturbances, induced by radio-frequency fields – AC mains voltage IEC 61000-4-6:2013 3 V 0.15–80 MHz 6 V ISM frequency bands 0.15–80 MHz 80% AM at 1 kHz	Compliant	
Immunity to voltage dips, short interruptions and voltage variations IEC 61000-4-11:2004	Compliant	
Electromagnetic compatibility (EMC)		
Interference immunity measurements SIP/SOP		
Immunity to electrical fast transients/bursts – I/O, SIP/SOP ports IEC 61000-4-4:2012 ± 1 kV 100 kHz repetition rate	Compliant	
Immunity to conducted disturbances, induced by radio-frequency fields – SIP/SOP ports IEC 61000-4-6:2013 3 V 0.15–80 MHz 6 V ISM frequency bands 0.15–80 MHz 80% AM at 1 kHz	Compliant	
Immunity to interference table, near fields of wireless HF communication devices		
Radio service	Frequency band MHz	Test level V/m
TETRA 400	380 - 390	27
GMRS 460 FRS 460	430 - 470	28
LTE band 13, 17	704 - 787	9

EN

Immunity to interference table, near fields of wireless HF communication devices		
Radio service	Frequency band MHz	Test level V/m
GSM 800/900 TETRA 800 iDEN 820 CDMA 850 LTE band 5	800 - 960	28
GSM 1800 CDMA 1900 GSM 1900 DECT LTE band 1, 3, 4, 25 UMTS	1700 - 1990	28
Bluetooth WLAN 802.11 b/g/n RFID 2450 LTE band 7	2400 - 2570	28
WLAN 802.11 a/n	5100 - 5800	9

4.1 Type plate

The type plates are on the motor cover and on the motor flange.

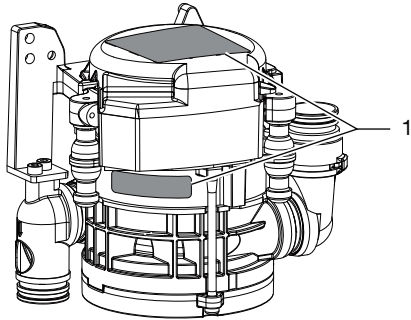

1 Type plate

4.2 Evaluation of conformity

This device has been subjected to conformity acceptance testing in accordance with the current relevant European Union guidelines. This equipment conforms to all relevant requirements.

EN

5 Operation

EN

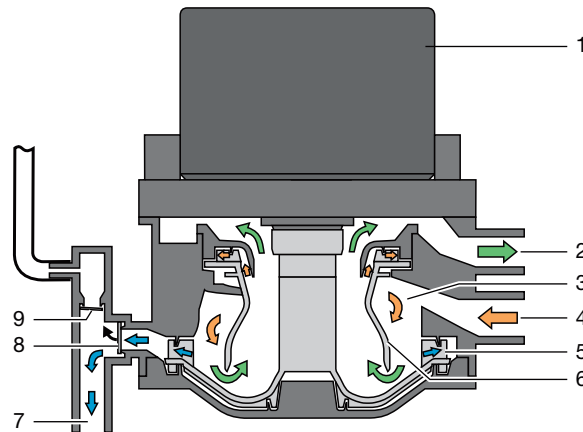

- 1 Motor
- 2 Vacuum, to suction unit
- 3 Separation
- 4 Aspiration input
- 5 Pump wheel
- 6 Separation rotor
- 7 Fluid output
- 8 Waste valve
- 9 Relief valve

5.1 Separation

Every time the suction hose is taken out of the hose manifold, the CS 1 Combi-Sepamatic and the suction unit are started.

The mixture of liquid and air drawn up is accelerated in the intake connection and then set in spiral motion in the separation. The resulting centrifugal forces sling the aspirated particles against the outer wall. The air is continuously separated from the fluid and escapes to the suction unit via the spinning separation rotor.

The aspirated air is subject to high centrifugal forces by the separation rotor, which ensures that no fluid or blood foam can be carried into the suction unit.

The spiral motion serves to continuously transport the separated liquid to the pump wheel, this then pumps the liquid into the central waste water drainage system via the waste water valve.

The air bleed is carried out via the relief valve. If fluid escapes upwards into the air bleed area following a fault, the relief valve closes automatically.

5.2 Station selection valve

The station selection valve interrupts the suction flow between the hose manifold and the suction unit.

As soon as a suction hose has been removed from the hose manifold, the station selection valve is opened and suction flow is enabled.

A station selection valve is already integrated in various versions of the CS 1. An external station selection valve can be electrically controlled via the CS 1.

Assembly

EN

6 Requirements

6.1 Setup options

CS 1 Combi-Sepamatic

- Directly in the treatment unit.
- In a special housing in an extension of the treatment unit.

6.2 Hose materials

For waste connections and suction lines only use the following hose types:

- Flexible spiral hoses made of PVC with integrated spiral or equivalent hoses
- Hoses that are resistant to dental disinfectants and chemicals



Plastic hoses will display signs of ageing over time. Therefore, they should be inspected regularly and replaced as necessary.

The following types of hoses must not be used:

- Rubber hoses
- Hoses made completely of PVC
- Hoses that are not sufficiently flexible

6.3 Installation and routing of hoses and pipes

- › Execute the on-site pipe installation in accordance with the applicable local regulations and standards.
- › Lay the hose installation of the drains to or from the unit at a sufficient incline.



If incorrectly laid, the hoses can become blocked with sedimentation.

6.4 Information about electrical connections

- › Ensure that the electrical connections to the mains power supply are established in accordance with current valid national and local regulations and standards governing the installation of low voltage units in medical facilities.

- › Install an all-pole disconnect switch with a contact opening width of at least 3 mm in the electrical connection to the mains power supply. It must be possible to secure the disconnect switch so that it cannot be inadvertently switched back on again.
- › Install electrical lines without mechanical tension.
- › Make the electrical connection via the main power switch of the treatment unit or via the main power switch of the practice.

6.5 Information about connecting cables

Mains supply cable

Installation type	Line layout (minimum requirements)
Fixed installation	– Plastic sheathed cable (e.g. type NYM-J)
Flexible	– PVC flexible line (e.g. H05 VV-F) or – Rubber connection (e.g. H05 RN-F or H05 RR-F)

Control cable

Installation type	Line layout (minimum requirements)
Fixed installation	– Shielded sheathed cable (e.g. (N)YM (St)-J)
Flexible	– PVC data cable with shielded cable sheathing, as used for telecommunications and IT processing systems (e.g. type LiYCY) or – Lightweight PVC control cable with shielded cable sheathing

Wire cross-section

Unit feed:

- 0.75 mm²

Connection external valves / units:

- 0.5 mm²

7 Installation

EN



WARNING

Infection due to contaminated unit

- Clean and disinfect the suction before working on the unit.
- Wear protective equipment when working (e. g. impermeable gloves, protective goggles and mouth and nose protection).



Prior to working on the unit or in case of danger, disconnect it from the mains.

7.1 Installation of the CS 1 in treatment units

Attach the unit vertically at a suitable position in the treatment unit. The unit is mounted on rubber pads and suspended in a metal frame. This mounting arrangement prevents the transmission of any vibrations to the treatment unit while the device is running. Vibrations may occur if the unit is not positioned vertically. A minimum distance of 3 mm must be maintained to the surroundings.

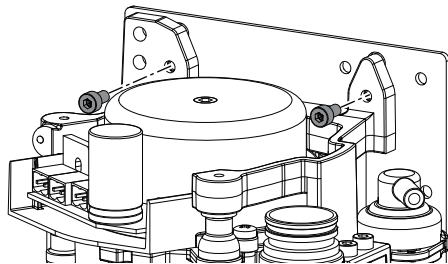

Station selection valve

In various types, the place selection valve is directly mounted on the CS 1. The station selection valve (for separate installation) should be fitted in the suction pipe in the treatment unit, preferably near the end connection in the floor socket. The electrical connection should then also be carried out on the CS 1. For further information, refer to the station selection valve installation and operating instructions

Inlet and outlet hoses

Connect and attach the inlet and outlet hoses with DürrConnect connectors to the relevant connections on the unit. Route the hoses at an incline.

Recommended diameter of the connection hoses: \varnothing 25 mm.

The minimum nominal width for the outlet hose is 15 mm.

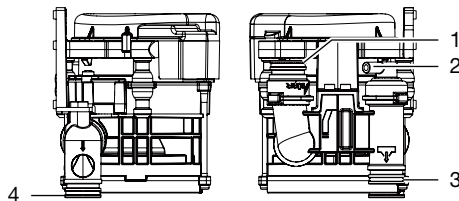

- 1 Hose manifold
- 2 Vent
- 3 Outlet
- 4 Suction unit

Rinsing unit

It is recommended that the suction system is equipped with a rinsing unit, e.g. in the treatment unit. The rinsing unit provides a small amount of water during aspiration. This dilutes the aspirated fluids (blood, saliva, rinsing water etc.), which can then be transported more effectively.

Installation sets

Installation sets and detailed documentation for various installation situations are available from the manufacturers.



When installed in a housing, ventilation slits should be provided to avoid heat build-up in the housing.

7.2 Power supply

- Safety transformer order number: 9000-150-46
- Safety transformer 24 V AC with an isolator consisting of two means of patient protection (MOPP) between the mains circuit and secondary circuit, min. 100 VA, secondary fuse T 4 AH (or IEC 60127-2/V T 4 AH, 250 V)

7.3 Electrical connections, controller

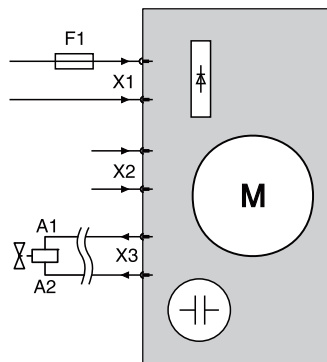

- X1 Power supply in accordance with EN 60601-1
- X2 Signal input / start signal
- X3 Place selection valve and/or rinsing unit 24 V DC (max. output: 8 W)
- F1 T 4 AH, 250 V in accordance with IEC 60127-2

7.4 Electrical connections

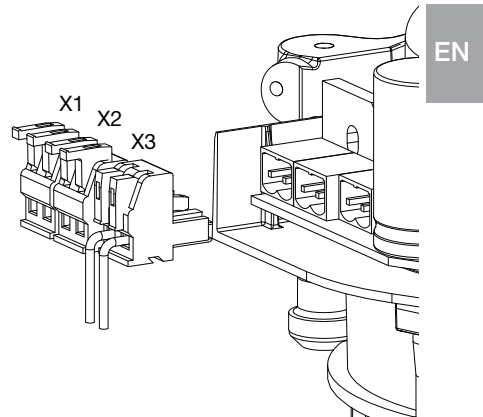

- X1 Power supply
- X2 Hose manifold start signal
- X3 Outgoing signal station selection valve and/or rinsing unit

- › Remove the motor cover of the CS 1.
- › Attach the connector to the connection lines.



To open, lift the terminal lever upwards.

- › Plug the connector onto the control.
- › Put the motor cover on.

8 Commissioning

EN



In many countries technical medical products and electrical devices are subject to regular checks at set intervals. The owner must be instructed accordingly.

- › Turn on the unit power switch or the main surgery switch.
- › Carry out an electrical safety check in accordance with applicable local regulations (e.g. the German Ordinance on the Installation, Operation and Use of Medical Devices / Medizinprodukte-Betreiberverordnung) and record the results as appropriate, e.g. in the technical log book.
- › Check the aspiration function.
- › Check the connections, hoses and device for leaks.

 Usage

9 Disinfection and cleaning

**NOTICE****Device malfunctions or damage due to use of incorrect media**

Guarantee claims may become invalid as a result.

- › Do not use any foaming agents such as household cleaning agents or instrument disinfectants.
- › Do not use abrasive cleaners.
- › Do not use agents containing chlorine.
- › Do not use any solvents like acetone.

Dürr Dental recommends

- For disinfection and cleaning: Orotol plus or Orotol ultra
- For cleaning: MD 555 cleaner

Only these products have been tested by Dürr Dental.

When using prophylaxis powders, Dürr Dental recommends the water-soluble Lunos prophylaxis powders in order to protect the Dürr Dental suction systems.

9.1 After every treatment

- › Aspirate a glass of cold water through the large and the small suction hoses. Do this even if only the small suction hose was actually used during treatment.



Suction through the large suction hose causes a large amount of air to be drawn up, thereby considerably increasing the cleaning effect.

9.2 Daily after the end of treatment



After higher workloads before the midday break and in the evening

The following are required for disinfection/cleaning:

- ✓ Non-foaming disinfectant/cleaning agent that is compatible with the materials.
- ✓ Unit care system, e.g. OroCup
- › To pre-clean, suck up 2 litres of water with the care system.
- › Aspirate the disinfection/cleaning agent with the care system.

9.3 Once or twice a week before the midday break



Under harsher conditions (e.g. hard water or frequent use of prophylaxis powders) 1x daily before the midday break

The following are required for cleaning:

- ✓ Special non-foaming detergent for suction units that is compatible with the materials.
- ✓ Unit care system, e.g. OroCup
- › To pre-clean, suck up 2 litres of water with the care system.
- › Aspirate the cleaning agent with the care system.
- › Rinse with ca. 2 l water after the application time.

EN

10 Maintenance

EN



All maintenance work must be performed by a qualified expert or by one of our Service Technicians.



WARNING

Infection due to contaminated unit

- › Clean and disinfect the suction before working on the unit.
- › Wear protective equipment when working (e. g. impermeable gloves, protective goggles and mouth and nose protection).



Prior to working on the unit or in case of danger, disconnect it from the mains.

Maintenance interval

Maintenance work

Dependent upon the level of usage of the device

- › Clean or replace the protective sieves at the aspiration inlet. At the latest, however, when the suction power of the unit diminishes.

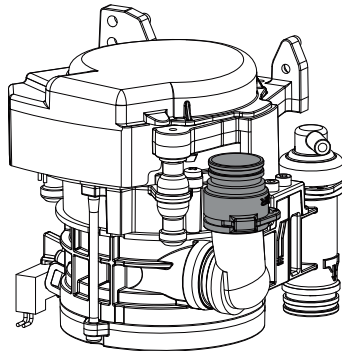

Annually	<ul style="list-style-type: none"> › Cleaning of the suction unit in accordance with the operating instructions. › Clean or replace the protective sieves at the aspiration inlet. › If a rinsing unit is present: clean the sieve in the water supply. * › Perform a functional test. *
Every 3 years	<ul style="list-style-type: none"> › Replace the rubber grommets on the connections. *
Every 5 years	<ul style="list-style-type: none"> › Replace the rubber grommets on the connections. * › Replace all o-rings in the device. *

* Only by customer services service technicians.

? Troubleshooting

11 Tips for operators and service technicians

EN



Any repairs exceeding routine maintenance may only be carried out by qualified personnel or our service.



WARNING

Infection due to contaminated unit

- › Clean and disinfect the suction before working on the unit.
- › Wear protective equipment when working (e. g. impermeable gloves, protective goggles and mouth and nose protection).



Prior to working on the unit or in case of danger, disconnect it from the mains.

Error	Possible cause	Remedy
Device does not start	No power supply	<ul style="list-style-type: none"> › Check power supply. * › Check the fuses and replace if necessary. *
	No start signal	<ul style="list-style-type: none"> › Check the control voltage at the signal input. *
Suction power too weak or interrupted	Coarse sieve is blocked on the inlet of the aspiration	<ul style="list-style-type: none"> › Clean the coarse sieve.
	Place selection valve not or incompletely open	<ul style="list-style-type: none"> › Check the control voltage. * › Clean the place selection valve. *

* Only to be done by service technicians.

11.1 Replacing the fuse

EN



Prior to working on the unit or in case of danger, disconnect it from the mains.

Transformer

- › Unscrew and remove the safety cover.
- › Replace the fuse.

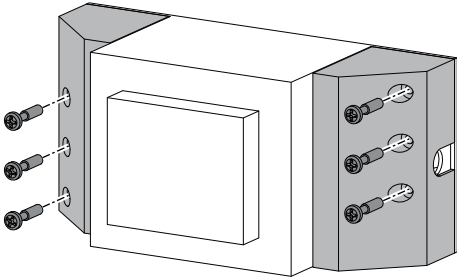

Fuse housing

- › Turn the fuse housing to open it.
- › Replace the fuse.

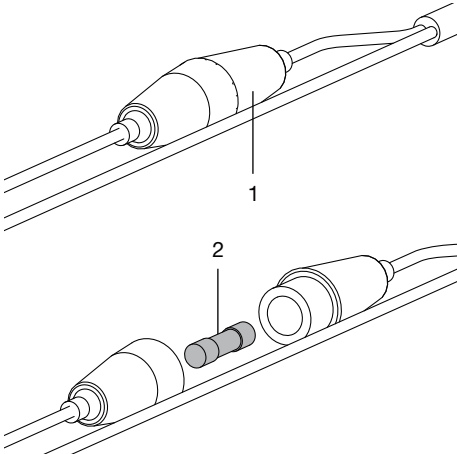

- 1 Fuse housing
- 2 Fuses

12 Transporting the unit



WARNING

Infection due to contaminated unit

- › Disinfect the unit before transport.
- › Close all media connections.



Wear protective equipment to avoid any risk of infection (e.g. liquid-tight protective gloves, protective goggles, face mask).

- › Before disassembly, clean and disinfect the suction unit and the unit using a suitable disinfectant approved by Dürr Dental.
- › Disinfect a defective unit using a suitable surface disinfection agent.
- › Seal all connections with sealing caps.
- › Pack the unit securely in preparation for transport.

12.1 Close the CS 1

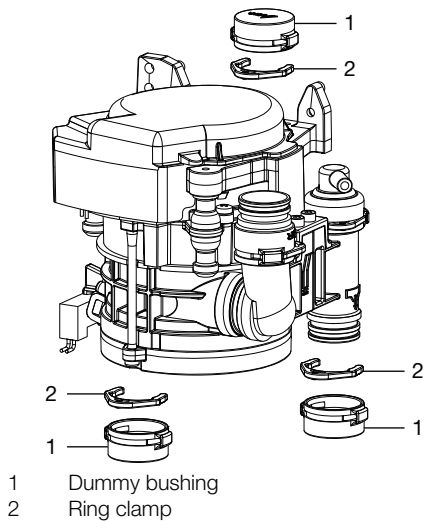

- 1 Dummy bushing
- 2 Ring clamp

 Appendix

EN

13 Handover record

This document confirms that a qualified handover of the medical device has taken place and that appropriate instructions have been provided for it. This must be carried out by a qualified adviser for the medical device, who will instruct you in the proper handling and operation of the medical device.

Product name	Order number (REF)	Serial number (SN)

- Visual inspection of the packaging for any damage
- Unpacking the medical device and checking for damage
- Confirmation of the completeness of the delivery
- Instruction in the proper handling and operation of the medical device based on the operating instructions

Notes:

Name of person receiving instruction:**Signature:**

Name and address of the qualified adviser for the medical device:

Date of handover:**Signature of the qualified adviser for the medical device:**

--	--

EN



Hersteller / Manufacturer:

DÜRR DENTAL SE
Höpfigheimer Str. 17
74321 Bietigheim-Bissingen
Germany
Fon: +49 7142 705-0
www.duerrdental.com
info@duerrdental.com



Minilight



Installation and use manual



LUZZANI DENTAL S.R.L.

Via Torino, 3
20030 Senago (MI)
Italy

www.luzzani.it

E-mail: info@luzzani.it

Tel.: +39 029988433
Fax: +39 0299010379

ED. 5 REV. 0



MADE IN ITALY



1 3 7 0

CONTENTS

- 0 — SYRINGE LEGEND
- 1 — WARNINGS
- 2 — PRODUCT DESCRIPTION
 - 2.1 — GENERAL
 - 2.2 — GENERAL CHARACTERISTICS
 - 2.3 — MODELS
 - 2.4 — CONTROLS
 - 2.5 — CE MARKING
- 3 — IDENTIFICATION DATA AND WARRANTY
 - 3.1 — MANUFACTURING BATCH
 - 3.2 — WARRANTY
- 4 — PACKAGING
- 5 — TECHNICAL CHARACTERISTICS
 - 5.1 — OPERATING CONDITIONS
 - 5.2 — TRANSPORT AND STORAGE CONDITIONS
- 6 — INSTALLATION AND CONNECTIONS
 - 6.1 — CONNECTION TO ELECTRICAL SYSTEM
 - 6.2 — CONNECTION TO HYDRAULIC SYSTEM
 - 6.3 — CONNECTION TO COMPRESSED AIR SYSTEM
 - 6.4 — CONNECTION OF STRESS ABSORBER CORD
 - 6.5 — NOTES FOR CORRECT CONNECTION
- 7 — NORMAL USE
 - 7.1 — INSUFFLATION OF COLD WATER
 - 7.2 — INSUFFLATION OF COLD AIR
 - 7.3 — COMBINED INSUFFLATION OF COLD WATER AND AIR (SPRAY)
 - 7.4 — INSUFFLATION OF WARM WATER (present in version 6f and L)
 - 7.5 — INSUFFLATION OF WARM AIR (present in version 6f and L)
 - 7.6 — COMBINED INSUFFLATION OF WARM WATER AND AIR (SPRAY) (present in version 6f and L)
 - 7.7 — LIGHT FUNCTION
 - 7.8 — FIRST TIME USE AND USE AFTER LONG PERIODS OF NON-USE
- 8 — CLEANING AND STERILIZATION
- 9 — MAINTENANCE
- 10 — DISPOSAL AND SCRAPPING
- 11 — INFORMATION FOR THE DENTIST
- 12 — FAULT REPORT FORM
- 13 — SYMBOLS
- 14 — WIRING DIAGRAM

0 — SYRINGE LEGEND

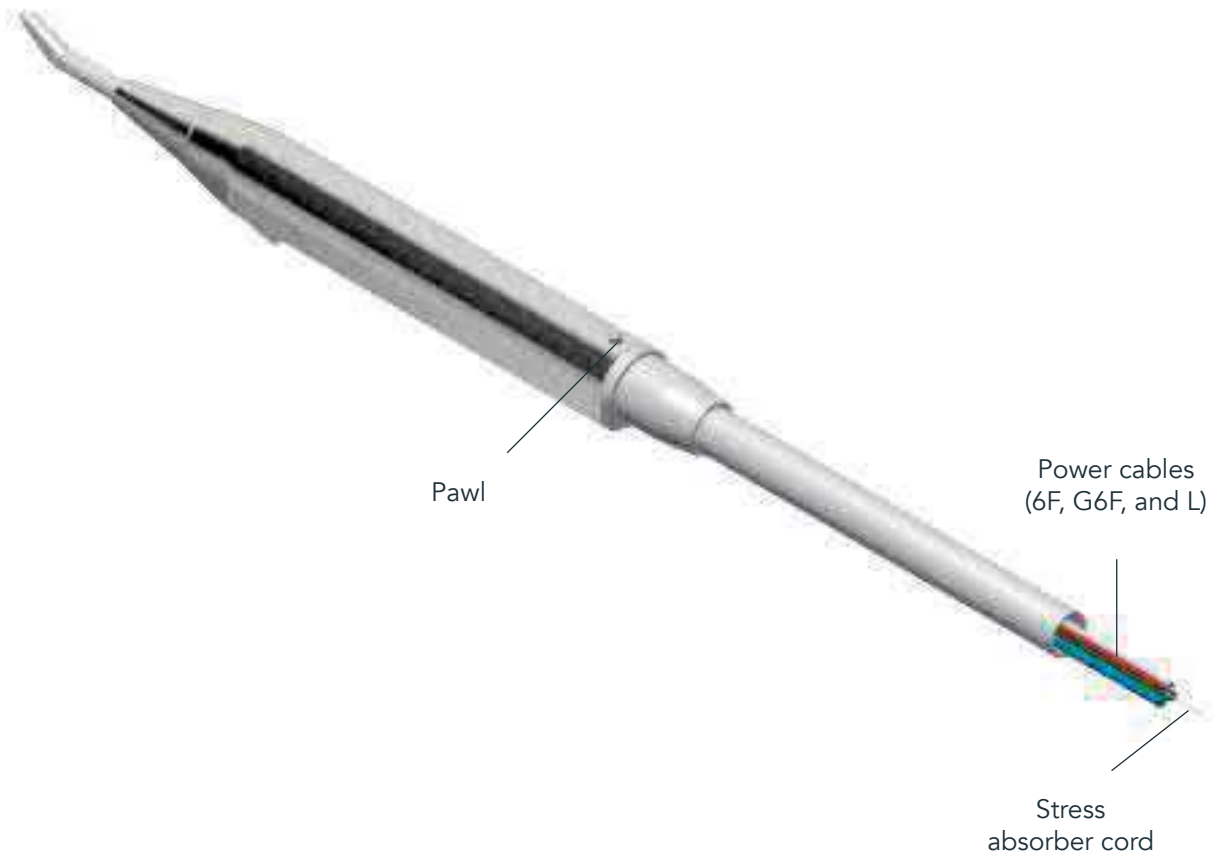
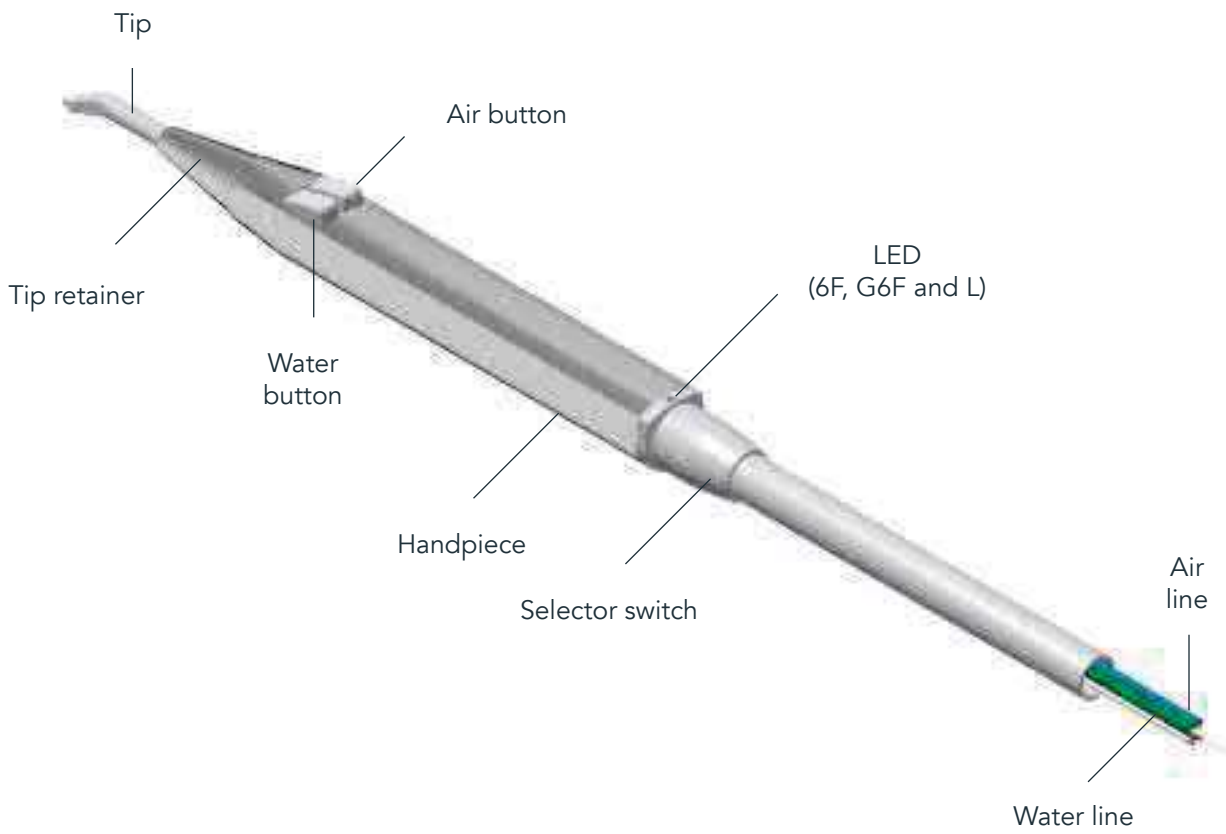

1 — WARNINGS

1.1 — Any unauthorised tampering, modification or improper use immediately terminates the warranty and exonerates our company from all liability for injury or damage to persons, animals or property that may be caused by such interference.

1.2 — To ensure maximum user and patient safety, the transformer used must be rated Safe Extra Low Voltage (SELV) with CE marking for medical use, in compliance with IEC 80.601 and IEC 60.601.

1.3 — Connection to terminals with output voltage exceeding 24 V could irreparably damage the device.

1.4 — The stress absorber cord must be anchored to the dental unit. This cord is designed to absorb any strains, thus preventing abnormal traction on the electrical or air/water line connections.

1.5 — Before use, the electric, water and air lines must be correctly connected. The syringe could be damaged if used when not connected to the water and air supplies. The lines must be connected correctly since inverting them would damage the syringe.

1.6 — To meet the requirements of Directive 93/42/EEC, the company has established a post-marketing surveillance procedure to monitor any problems generated by the use of our products. The attached form allows you to report any faults and suggest improvements which will be considered for subsequent versions of the product.

1.7 — With each syringe, the package also includes a User's manual which also includes a "Fault Report Form". Since this is required by law, the user must receive this User's manual. Therefore, the syringe installer is responsible for delivering this User's manual to the dentist. Directive 93/42/EEC requires product traceability: therefore, our customers are asked to ensure that, in case of emergency, we can identify the end customer to whom the product has been sold.

1.8 — Manufacturers and/or installers of dental units are required to comply with all the prescriptions outlined in this document.

1.9 — Use the Minilight syringe only for the applications described in the instructions for use.

1.10 — This product must only be installed by qualified persons.

1.11 — Never modify the syringe in any way. This is strictly forbidden.

1.12 — Use only original parts produced or approved by the manufacturer. If non-OEM accessories or consumables are used, the company cannot guarantee safe operation and function. No claims can be made for damages resulting from improper use.

1.13 — Disposable tip adapters are not part of the Minilight Syringe and may compromise proper functioning.

1.14 — Do not use the device in close contact with anaesthetic gases or in highly oxygenated environments (with an oxygen content >25%) or in areas where there is a risk of explosion.

1.15 — Do not perform any maintenance procedures not indicated in the manual.

1.16 — Before using the syringe, make certain that the water and air supplies have been activated.

1.17 — National regulations regarding dental unit water and air quality must be met.

1.18 — The air used must be dry, clean and free of oil.

1.19 — The Minilight syringe meets the requirements laid out in European Council Directive 93/42/EEC: Class II A

1.20 — The Minilight syringe must not be used near or set on other devices.

1.21 — Use only accessories, cables, transducers specified or supplied by Luzzani Dental.

1.22 — Do not use mobile RF communication devices within a distance less than 30 cm from the device.

2 — PRODUCT DESCRIPTION

2.1 — GENERAL

The Minilight syringe is a medical device designed to blow air and water (separately or together, at room temperature or at body temperature) to clean and/or dry the oral cavity during any dental procedure. It has been designed for use in dentist offices and dental clinics and is built into dental unit used exclusively by dentists. Product life — under proper maintenance conditions — is 5 years.

2.2 — GENERAL CHARACTERISTICS

- The Minilight syringe is a medical device for dental use (class II a).
- Protection rating against direct contacts: B
- Temporary operation: 10 sec. ON/ 20 sec. OFF.

The Minilight syringe has been designed using the latest ergonomic concepts for easy use and immediate cleaning and sterilisation. Both the tip and handpiece can easily be removed for perfect autoclave disinfection and sterilisation at 134°C (see point 8). Several handpieces of different shape are available. Choose the shape you need: angled or stylet. The air and water can also be heated to body temperature, thus sparing the patient even the slightest discomfort induced by insufflation of products at ambient temperature.

2.3 — MODELS

The models are differentiated into versions based on the

number of functions provided:

- 3F: cold water/air/spray
- 6F: cold water/air/spray - warm water/air/spray
- G3F: cold water/air/spray (air and water inverted)
- G6F: warm water/air/spray (air and water inverted)
- A: cold water or air only
- L: cold/warm water, air and spray + light

Note:

Models 3F, G3F, 6F, G6F and L can be recognized by the printing on the back of the syringe.



Various handpieces, that differ in shape, can be mounted on all versions of the Minilight syringe.

The shape of the handpiece can be:

STYLET



ANGLED



This difference lets the dentist choose the tool ergonomically best suited for the purpose. To guarantee maximum hygiene and atoxicity, the handpieces are made of stainless steel. The devices are produced entirely in our workshop, with a tested, constantly updated work cycle using the most sophisticated machinery compliant with current quality system directives (UNI EN ISO 13485 certified).

2.4 — CONTROLS

Every syringe and all of its parts undergo duly documented, 100% complete functional and safety testing to ensure that the technical and functional design requirements are fully met.

2.5 — CE MARKING

All products bear CE marking both on syringe handpiece and inside. (batch number, autoclave symbol, Luzzani Dental logo, product name, CE marking with Notified Body number). The User's manual supplied with the product also includes details of our company, the main product characteristics and instructions for correct use and maintenance.

3 — IDENTIFICATION DATA AND WARRANTY

3.1 — MANUFACTURING BATCH

A number, marked on the inside of each product, identifies the production batch; the number is printed on the central body of the syringe. This number uniquely identifies the production batch thus always guaranteeing traceability of the product and each of its components, with relative test sheets.

3.2 — WARRANTY

The product is guaranteed by our company for 12 months from the date of the delivery document. The warranty covers any device manufacturing defects (materials) and is limited solely to the replacement of defective parts, performed in our workshop. The product must be sent to our premises at the expense of the customer. For the warranty to be valid, the product must be returned intact, complete and showing with no signs of tampering. The syringe has no functional expiration date; its expected life span is 5 years.

4 — PACKAGING

The product is shipped in suitable packaging to prevent problems during transport. The packaging consists of a plastic bag containing the Minilight syringe. A protective handpiece sheath and tip-saving tube protect the syringe during transport. Several bags are placed in one box. The Minilight syringe comes ready for connection to the dental unit once all packaging has been removed. For the correct use of the syringe, the protective tube must also be removed from the tip.

 **IMPORTANT NOTE:**

With each syringe, the package also includes a User's manual which also includes a "Fault Report Form". Since this is required by law, the user must receive this User's manual. Therefore, the syringe installer is responsible for delivering these forms to the dentist. Directive 93/42/EEC requires product traceability: therefore, our customers are asked to ensure that we can identify the end customer to whom the product has been sold.

5 — TECHNICAL CHARACTERISTICS

FUNCTIONS		6F	3F	L
Supply voltage	V~	24	***	24
LED voltage	Vdc	***	***	3,5
Max. absorbed current	A	4,3	***	4,3
Electrical power	W	103	***	103
Water supply pressure	Kpa	250	250	250
Air supply pressure	Kpa	450	450	450
Water flow rate	Cc/min	110	110	110
Air flow rate	NI/min	10	10	10
International protection		IP40	IP40	IP40

5.1 — OPERATING CONDITIONS

Ambient temperature	10°C / +45°C
Relative air humidity	30% / 85%
Atmospheric pressure	80 Kpa - 106 Kpa

5.2 — TRANSPORT AND STORAGE CONDITIONS

Temperature	-20°C / +60°C
Relative Humidity	30% / 85%
Atmospheric Pressure	50 Kpa - 106 Kpa

6 — INSTALLATION AND CONNECTIONS

6.1 — CONNECTION TO ELECTRICAL SYSTEM

The connection involves hooking up the two electrical terminals to the transformer, arranged to provide an output of 24 V (see wiring diagram 14.1). Model L only: voltage for LED light 3.3 Vdc: black wire (+), white wire (-)

 **NOTE**

- The electric power supply and transformer used must be rated Safe Extra Low Voltage (SELV) for medical use, in compliance with the mandatory regulations.
- Connection to terminals with output voltage exceeding 24 V could irreparably damage the unit and compromise safety.

6.2 — CONNECTION TO HYDRAULIC SYSTEM

The syringe's green line must be hooked up to the water supply.

 **NOTE**

- The operating pressure is 250 kPa. A slight increase in pressure would only increase the power of the jet, but would not create any problems and is not dangerous.
- The water used must be potable water, filtered (<25 µm) and free of bacteria, etc.
- For the syringe to function properly, the water pressure must not be lower than indicated.

6.2 — CONNECTION TO COMPRESSED AIR SYSTEM

The syringe's blue line must be connected to the compressed air system.

 **NOTE**

- The recommended operating pressure is around 450 kPa.
- When using the Minilight syringe, national regulations regarding water and air quality must also be met.
- The air must be medical grade, dry and free of oil and bacteria – a 5µm air filter is recommended.

6.4 — CONNECTION OF STRESS ABSORBER CORD

The stress absorber cord must be anchored to the dental

unit. This cord is designed to absorb any strains, thus preventing abnormal traction on the electrical or air/water line connections. The manufacturer cannot be held liable for malfunctions caused by failure to anchor the stress absorber cord.

6.5 — NOTES FOR CORRECT CONNECTION

- Before carrying out functional tests, both the electric, water and air lines must be correctly connected.
- Using the syringe without connecting the water and air supplies could damage the syringe.
- The lines must be connected carefully since inverting them could damage the syringe.

7 — NORMAL USE

7.1 — INSUFFLATION OF COLD WATER

To blow cold water into the operating field, just press the left button on the handpiece, symbol: 

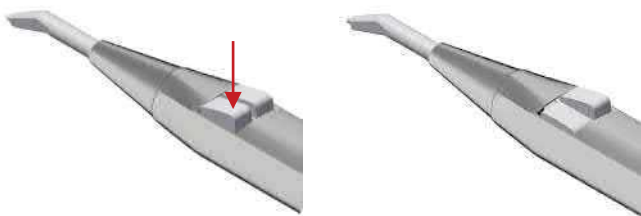

7.2 — INSUFFLATION OF COLD AIR

To insufflate cold air into the operating field, just press the right button on the handpiece, symbol: 

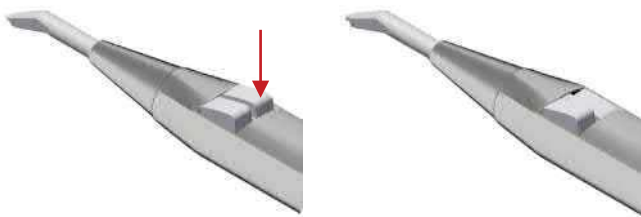

7.3 — COMBINED INSUFFLATION OF COLD WATER AND AIR (SPRAY)

To blow a combination of cold air and water (spray), press both buttons on the handpiece at the same time:

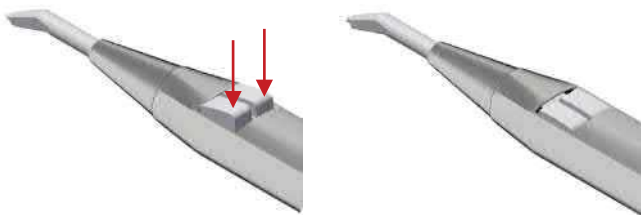

7.4 — INSUFFLATION OF WARM WATER (present in version 6f and L)

To blow warm water into the operating field, turn the selector switch at the base of the handpiece to the right (the green

LED lights up)



and press the left button on the handpiece:

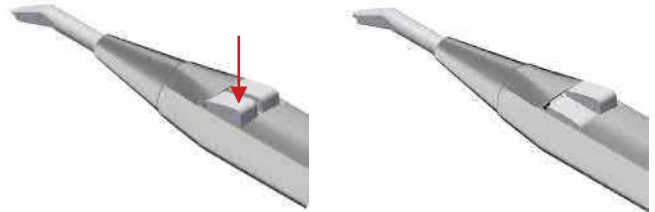

7.5 — INSUFFLATION OF WARM AIR (present in version 6f and L)

To blow warm air into the operating field, turn the selector switch at the base of the handpiece to the right (the green LED lights up):

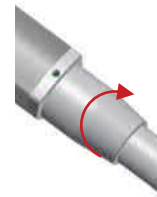

and press the right button on the handpiece:

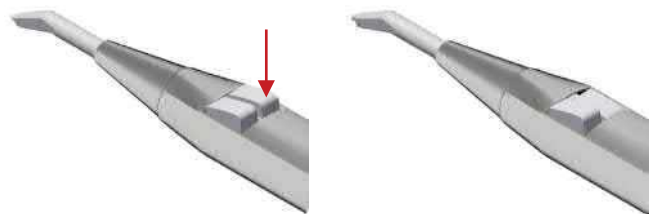

7.6 — COMBINED INSUFFLATION OF WARM WATER AND AIR (SPRAY) (present in version 6f and L)

To blow a combination of warm air and water (spray), turn the selector switch at the base of the handpiece to the right (the green LED lights up)



and press both buttons on the handpiece at the same time:

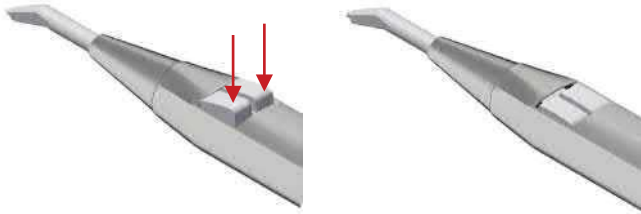

7.7 — LIGHT FUNCTION (present in version L)

This function is present in the Minilight L version. In this model, the handpiece has an optical fibre that conducts the light generated by a LED located in the body of the syringe. We recommend using a switch to turn the LED on and off. For connections, see wiring diagram 14.2.



NOTE

- The sole function of the selector switch is to preselect warm operations. The water and/or air are only heated at the moment in which they are actually used.
- The cleaning (or line washing) procedures must always be performed in the cold position.

WARNING

Do not use the tip improperly. Remove and sterilise the tip after each patient.

IMPORTANT

Air and water must be able to flow freely from the tip. Do not rest the tip on the tooth or on an object. Do not press the tip against impression materials as they could cause obstruction

7.8 — FIRST TIME USE AND USE AFTER LONG INTERVALS

-  Sterilize the handpiece and all accessories before use.
- After prolonged periods of inactivity, clean, treat and sterilise the handpiece.

BEFORE EACH PATIENT

1. Make certain the handpiece has been sterilised.
2. Adjust the supply of fluids from the dental unit (see table in point 5).
3. Press the air button and make certain that there is a clearly perceptible jet of air.
4. Check the water flow rate.
5. Use only filtered water that is free of oil and microorganisms.

6. Check the tip for any obstructions or deposits. Clean if necessary.

NOTE

- Flush out the syringe at the beginning of each work day (minimum flushing time: 2 minutes) and before each patient (minimum flushing time: 20-30 sec.).
- Immediately upstream of the syringe, install filters able to retain the microorganisms coming from the hydro-pneumatic circuit.

8 — CLEANING AND STERILIZATION

-  After each use on a patient, the handpiece and tip of the syringe **MUST** be cleaned and sterilised to guarantee maximum hygiene.

Sterilisation symbol on the handpiece: 

To do this, proceed as follows:

Disconnect the tip by unscrewing the tip retainer

1. unscrew the tip retainer



2. withdraw the tip retainer



3. withdraw the tip



or remove the entire handpiece by pressing the button on the lower part of the handpiece and pulling upwards.

1. press the pawl to release the handpiece

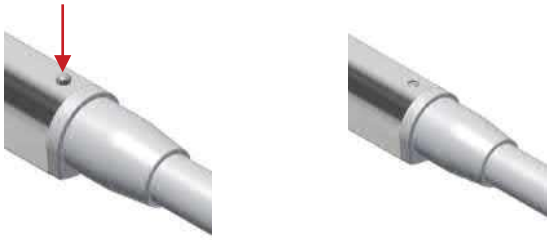

2. withdraw handpiece



wipe with a damp cloth, removing any stains. Set in a steam autoclave at 134°C for AT LEAST 3 minutes (in compliance with CEI EN 13060).

A — WARNINGS



The syringe should always be sterilised, even before using it for the first time.

- Inappropriate sterilisation is hazardous for the patient and for the operators.
- Do not perform spray disinfection.
- Do not immerse in disinfectant liquids.
- Do not perform cold or hot air chemical sterilisation.
- The personnel performing the task must be skilled and specially trained.
- Use disinfectant according to the specifications on the manufacturer label.
- Do not use chlorine-based liquids.
- When simultaneously sterilising more than one item in an autoclave, check that the load does not exceed the maximum allowed.

B — PREPARATION

Eliminate surface dirt using a disposable paper towel. Clean the inside of the lines by running air and water through the syringe for about 30 seconds. Remove the stainless-steel handpiece by pressing the button on its terminal section. Unscrew the tip retainer and remove the tip.

C — MANUAL CLEANING

Use a disposable paper towel and potable water to remove any impurities or dirt that may be present

D — AUTOMATIC CLEANING

Not envisaged

E — MANUAL DISINFECTION

Disinfect only with a disposable cloth and the permitted disinfectant (following the instructions on the label and product technical data sheet).

Recommended disinfectants:

- Incidin liquid
- FD 322 Durr
- Mikrozyd AF liquid

F — AUTOMATIC DISINFECTION

Not envisaged

G — MANUAL DRYING

Dry with disposable paper towelling. Dry with clean, dry, uncontaminated compressed air, inside and out, continuing until completely dry. Do not dry with hot air.

H — AUTOMATIC DRYING

Not envisaged

I — MAINTENANCE AND CONTROL

No special maintenance is necessary. There is no objective period of time that limits the useful life of the handpiece: visually check for damage and signs of wear, and if found, replace the part.

L — PACKAGING

Use heat sealable film-paper sterilisation pouches of appropriate size.



M — STERILISATION



The handpiece and tip can be sterilised.

Sterilise in a class B steam autoclave in compliance with EN 13060 ISO 17665-1.

3-phase sterilisation with fractional vacuum system at 134°C +/- 1°C at a pressure of 2.13 bar, applying a 4-minute delay. Never exceed 134°C. The autoclave must be validated.

N — STORAGE

No particular requirements apart from storage in the sealed, sterilised pouches. Store in a suitable place that is dry, out of direct sunlight and possibly with low bioburden.

9 — MAINTENANCE

The instrument requires no specific maintenance apart from normal cleaning and sterilisation as described in the previous paragraph.

10 — DISPOSAL AND SCRAPPING

-  The product does not contain dangerous or toxic-hazardous components. Separate waste collection is required for electrical equipment. Follow the regulations in force in your country.

11 — INFORMATION FOR THE DENTIST













-  The dental unit manufacturer is required to deliver the Luzzani Dental syringe User's manual to the end user.

12 — FAULT REPORT FORM

To meet the requirements of Directive 93/42/CEE as amended, the company has established a post-marketing surveillance procedure to monitor any problems generated by the use of our products. This commitment includes the requirement that both user and manufacturer inform the competent authorities of any incident caused to patient or user by malfunction or deterioration in the characteristics and/or performance of a device, as well as any inadequacy in the instructions for use. We kindly ask you to inform us of any anomalies by sending us the sheet attached to the last page of this manual.

13 — SYMBOLS

SYMBOLS

- | | | | |
|---|---|---|-----------------------|
|  | Do not overturn |  | Batch number |
|  | Fragile |  | Sterilise |
|  | Keep dry |  | Consult User's manual |
|  | Type B device | | |
|  | Alternating current | | |
|  | General warnings | | |
|  | Separate collection for electrical and electronic equipment | | |
|  | Manufacturer | | |
|  | Double insulation | | |

14 — WIRING DIAGRAM



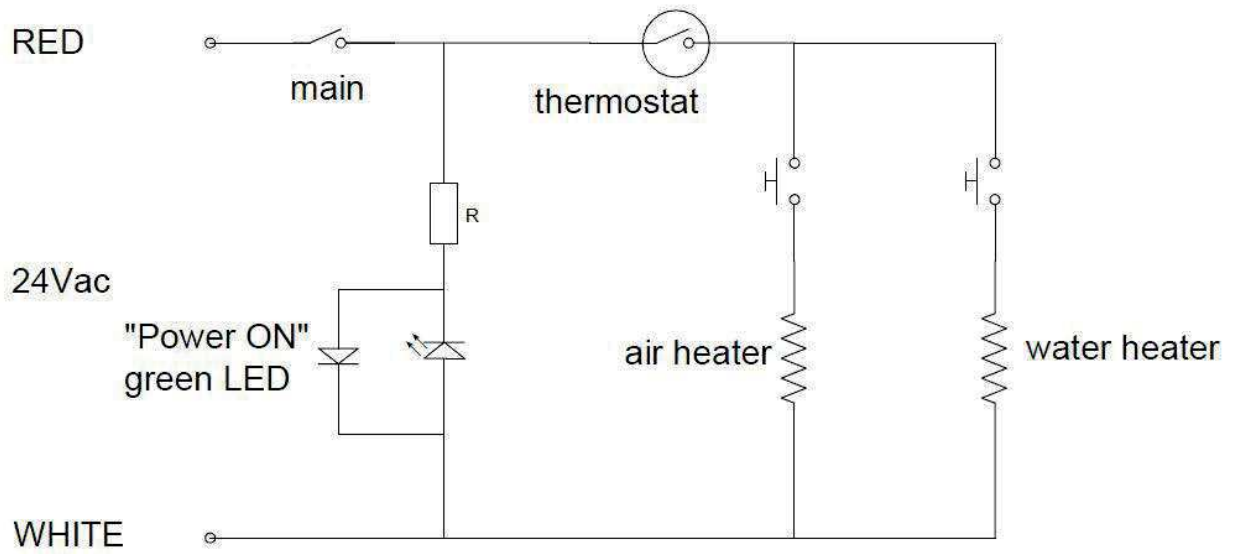

14.1 – VERSION 6F

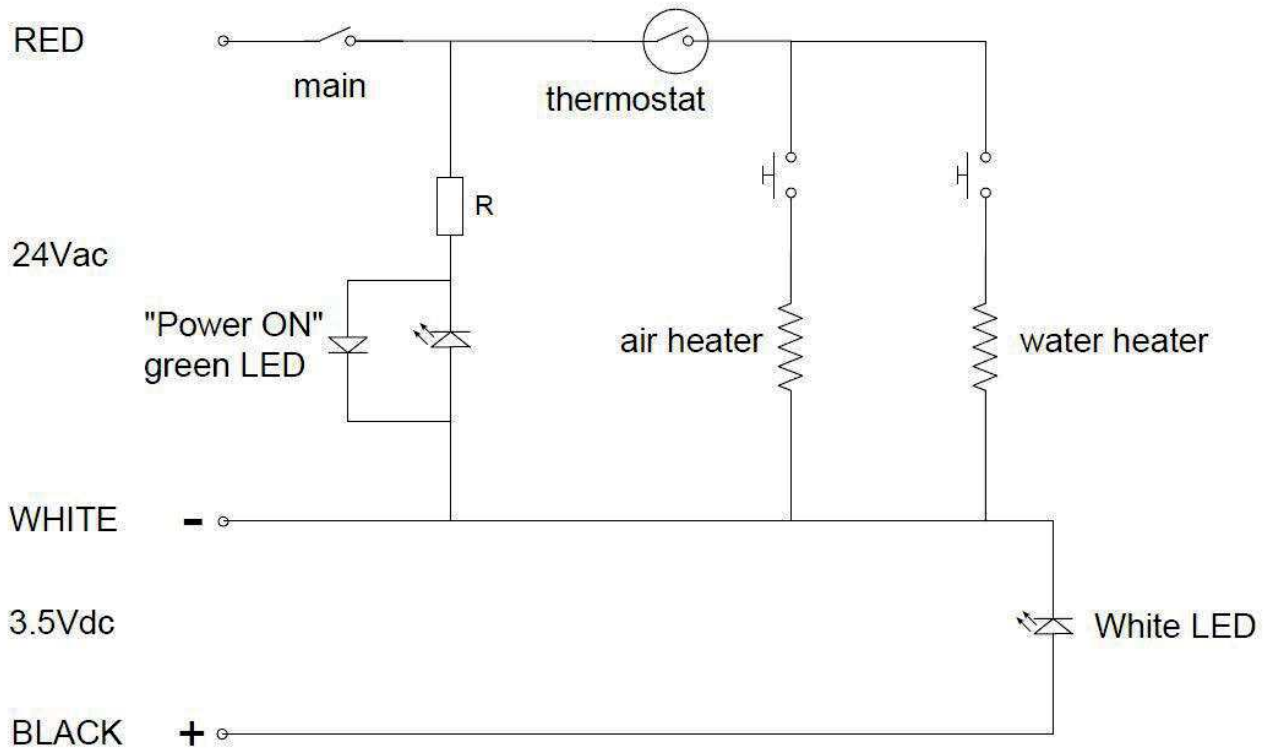

14.2 – VERSION L



INSTRUCTIONS FOR CLEANING AND STERILIZATION OF MINILIGHT, MINIMATE, MINIBRIGHT SYRINGES IN ACCORDANCE WITH UNI EN ISO 17665 REQUIREMENTS

<p>Warning</p> 	<ul style="list-style-type: none"> • Sterilization must be performed even when using the syringe for the first time. • Inappropriate sterilization is dangerous for patients and operators. • Do not perform spray sterilization. Do not place in any disinfectant liquids. • Do not perform cold chemical or hot air sterilization. • The appointed staff must be specialized and trained. • Use the disinfectant in accordance with the specifications set by the manufacturer indicated on the label. • Do not use chlorine-based solutions. • When sterilizing more than one piece in one autoclave do not exceed its maximum load capacity.
<p>Preparation</p>	<p>Remove dirt from the surface using a disposable paper tissue. Let air and water flow from the syringe for about 30 seconds in order to clean the internal channels. Press the button located at the bottom of the sleeve and slide the stainless steel sleeve off the syringe body. Unscrew the ferrule and remove the tip.</p>
<p>Manual cleansing</p>	<p>Wipe with a disposable paper tissue and with the aid of drinking water to remove any impurities and dirt</p>
<p>Automatic cleansing</p> 	<p>Not available</p>
<p>Manual disinfection</p>	<p>Perform disinfection only with a disposable tissue and with compatible disinfectants (in accordance with the instructions included in the product label and technical data sheet). Recommended disinfectants:</p> <ul style="list-style-type: none"> • Incidin liquid • FD 322 Durr • Mikrozyd AF Liquid
<p>Automatic disinfection</p> 	<p>Not available</p>
<p>Manual drying</p>	<p>Dry with disposable paper tissue. Dry with dry, clean and uncontaminated compressed air both internally and externally until completely dry. Do not dry with hot air.</p>
<p>Automatic drying</p>	<p>Not available</p>
<p>Maintenance and checking</p>	<p>No particular maintenance is required. There is no objective term limiting the usage life of the sleeve: check to see if there are if any damages or signs of wear and tear, replace the part if necessary.</p>
<p>Packaging</p>	<p>Use appropriately sized sterilization packages made of thermoweldable film.</p>
<p>Sterilization</p> 	<p>The sleeve and tip are autoclavable. Sterilize using EN 13060 ISO 17665-1 compliant class-B steam autoclave. Sterilize with 3 phases fractionated vacuum 134° C +/- 1 °C with 2.13 bar pressure, 4 minutes wait. Never exceed 135° C. The autoclave must be validated.</p>
<p>Preservation</p>	<p>No particular requirements other than keeping them in their sealed and sterilized package. Keep them in an appropriate environment and out of direct sunlight and in a dry place, which should have low bioburden where possible.</p>

FAULT REPORT FORM

PRODUCT _____

TYPE _____ BATCH _____

REPORTED BY _____

COMPANY _____

TYPE OF REPORT

ANOMALY

SUGGESTIONS

DESCRIPTION

NOTES

DATE _____

SIGNATURE _____

SEND TO:

LUZZANI DENTAL SRL
Via Torino 3 - Senago (MI) - ITALY
Tel. +39 02 99010379)



EVA

USER MANUAL



EXPERIENCE AND INNOVATION
SINCE 1948

TABLE OF CONTENTS

1	SYMBOLS USED	3
1.1	SYMBOLS USED IN THIS MANUAL	3
1.2	SYMBOLS USED IN THE LABELLING AND ON THE PACKAGING	3
2	INTENDED USE.....	4
2.1	INTENDED USER	4
2.1.1	Professional qualification.....	4
2.1.2	Minimum skills.....	4
2.1.3	Experience	4
2.1.4	Possible user handicaps.....	4
3	DESCRIPTION OF THE PRODUCT.....	5
3.1	DESCRIPTION OF COMMON USER'S INTERFACE	6
4	INSTRUCTION FOR USE	6
4.1	SWITCHING ON/ OFF.....	6
4.2	ADJUSTING THE LIGHT INSTENSITY	6
4.3	CHANGING COLOR TEMPERATURE ON TUNABLE WHITE VERSION	7
4.4	COMPOSAVE SETTING ON TUNABLE WHITE VERSION	8
4.5	MINIMUM INTENSITY SETTING ON SOLAR VERSION	8
4.6	AUTO-ON SETTING	8
4.7	SWITCHING ON/ OFF THEIA.....	8
4.8	REMOTE CONTROL.....	8
4.9	SYNCRO MODE WITH FARO ROOM LIGHT	9
5	PREVENTIVE MAINTENANCE AND ROUTINE CHECKS	10
6	CLEANING AND DISINFECTION.....	11
6.1	CLEANING OF THE REFLECTING PARABOLAS	11
6.2	CLEANING AND DISINFECTION OF THE HEAD	11
6.3	CLEANING AND DISINFECTION OF ARMS.....	11
7	STERILIZATION OF THE HANDLES	11
7.1	REMOVAL OF THE HANDLES	11
7.2	DECONTAMINATION AND DISINFECTION.....	11
7.3	STERILIZATION	11
8	TROUBLESHOOTING.....	12
8.1	ERROR LIST.....	12
9	TECHCNICAL SPECIFICATIONS.....	12
9.1	STORAGE AND TRANSPORTATION: ENVIRONMENTAL CONDITIONS.....	13
9.2	USE: ENVIRONMENTAL CONDITIONS.....	13

Dear Customer,

FARO hopes you enjoy your work with the new high quality light. For safe work and to take full advantage of the performance of the product, read carefully this manual before using the device.

In particular, follow all the warnings and the notes described into the Safety Recommendations included in the Packaging .

Warranty Conditions:

FARO offers the final customer a **24 month warranty** starting from the date of installation until a maximum of 30 months from the manufacturing date.

Repairs under warranty must be performed by FARO or its approved Service network.

Warranty is considered valid only when:

- the user sent the Certificate of Warranty duly filled out at the following email: service@faro.it
- the user registered the warranty throughout the Faro website;

The warranty covers manufacturing and engineering defects; in case of valid claims, the warranty covers free parts replacement only. Manhour work is not included in the warranty.





The warranty is not considered valid, at the sole discretion of FARO, if the fault is due to tampering, damage, unauthorized changes to the product, incorrect use, improper maintenance and normal wear and tear.

This product have a Service Life of: 10 Years.

Any serious incident occurring in relation to the device should be reported to the Manufacturer and the competent authority of the Member State in which the user and/or patient is established.

1 SYMBOLS USED

1.1 SYMBOLS USED IN THIS MANUAL

	<i>WARNING</i>
The paragraphs marked with this symbol contain instructions that must be carefully followed to avoid damaging the device, harming the operator or the patient.	
	<i>CAUTION</i>
These instructions warns you that you must pay attention to avoid situations that could damage the device.	
	<i>FORBIDDEN</i>
This icon highlights what you should not do to avoid damaging the device.	
	<i>NOTES</i>
This icon supplies information that allows you to use the device more efficiently.	

1.2 SYMBOLS USED IN THE LABELLING AND ON THE PACKAGING

The data plate is fixed:

- for the complete light or arms: on the rear arm
- for the head: under the heat sink cover

Serial Number description







- For dental light YYLDNNNNNN
- For head of dental light YYTENNNNNN













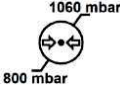



Where

- YY: last two digit of the year of manufacturing
- NNNNNN: progressive counter of the year

e.g.: 2ILD000001 I the first product manufactured in 2021.

The following standardized symbols are also present:

Symbol	Description
	Mark for Conformitè Europe
	Medical Device according to Regulation (EU) 2017/745 of the European Parliament and of the Council of 5 April 2017 on medical devices,
	Read the instructions use. Supplied by Electronic means.
	Manufacturer symbol according to Regulation (EU) 2017/745
	The instructions for use include safety warnings
	WEEE equipment according to the Directive 2012/19/EC. Dispose of the product according to this directive.
	Double insulation. Class 2 device against electrical risk

Symbol	Description
	Serial Number
	Can be sterilized with heat at 134°C
	Use the device at a temperature between 10°C and 40°C
	Use the device at pressure between 80 kPa and 106 kPa
	Use the device at relative humidity between 30 RH and 75RH
	Symbol to adjust light intensity
	Symbol to switch on/off the light
	Symbol to switch on/off the light on the rear arm (Alya with Theia Tech)
	High
	Fragile
	Protect the packaging from rain and high humidity
	Do not Roll
	Do not use hooks
	Maximum stackable weight
	Storage and Transportation temperatures
	Storage and Transportation Relative Humidity
	Storage and Transportation Atmospheric Pressure
	Recyclable cardboard

2 INTENDED USE

The device is used in dental office and is intended for illuminating the oral cavity and oral structures of patients in dentistry. In the normal use, the device is positioned distance of 700mm from the operative area, the distance for which the lighting features were designed. Patients can be of all ages with typical dental pathologies.

2.1 INTENDED USER

The intended users are Dentists (all specializations) or Dental Nurse, Hygienists and Assistants

2.1.1 Professional qualification:

Degree in Medicine with Dentistry Specialization

Degree in Dentistry

Degree in dental nursery

2.1.2 Minimum skills

Those planned for the professional qualification

Understanding of language: Those acquired for the professional qualification

2.1.3 Experience

Those outlined to conduct the profession

2.1.4 Possible user handicaps

For the use it is necessary at least one upper limb;

Visual faculty compatible with the profession;

The user with these characteristics does not require any special training

3 DESCRIPTION OF THE PRODUCT

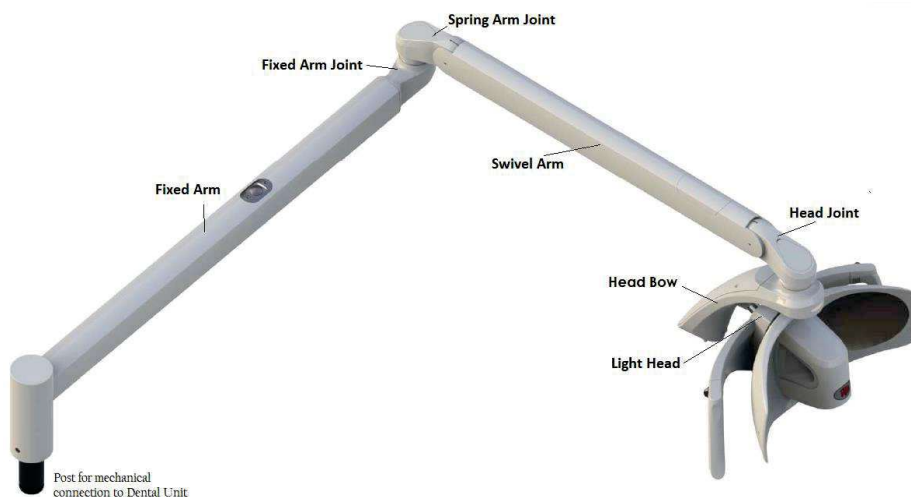

Picture 1 –Dental Light – Unit Mount



Picture 2 –Dental Light – Ceiling Mount

The device is available in two main product variants:

- EVA with light source at 5000 K with “Sunlight” Spectrum
- EVA with Tunable White light source (4000 K, 5000 K, 5700 K, Composable setting (2700 K)) selectable by the operator.

These main variants can be supplied with:

- Different Mounting;
- Different arm length combination
- Canbus Technology
- Remote cable for bring the command to the Dental Unit’s
- Auto-on setting;
- Theia Technology (secondary light source under fixed arm);
- Integrated Camera 2K or 4K;
- RF for the connection with FARO’s room lights (Siderèa)

All variants can be ordered by dedicated product codes as reported in the table below:

Mounting		Swivel Arm		Fixed Arm		Light Source / Integrated Camera		Command / radiofrequency (RF)		Cables		Custom ⁽¹⁾	
1-2 DIGIT		3° DIGIT		4° DIGIT		5° DIGIT		6° DIGIT		7° DIGIT		8° -9° DIGIT	
5	U	0	Only Head No arms	0	Only Head No arms	0	Tunable White	0	Joystick	0	Standard	00	Std faro
5	C	1	550 mm	1	600 mm	1	Sunlight 5000K	1	Joystick RF	1	Remote Control Bus Cable	JJ	(4)
5	T	2	855 mm	2	600 mm Theia	2	Tunable White Integrated Camera	2	Sensor				
				3	820 mm	3	Sunlight 5000K Integrated Camera	3	Sensor RF				
				4	820 mm Theia	4	cNus Tunable ⁽²⁾⁽³⁾						
				5	960 mm	5	cNus Sunlight 5000K ⁽²⁾⁽³⁾						
				6	960 mm Theia								

(1) Customized codes include only aesthetic customization having no impact on Safety and EMC requirements

(2) cNus mark for North America cannot be coupled with the following variant codes:

Digit 1-2: 5T

Digit 3: 0

Digit 5: 2 - 3

(3) Ceiling Mounting Versions with cNus Mark are considered Fixed Applications and must be connected to Earth Protection. These devices are Class 1 Insulation according to IEC 60601-1.

(4) Aesthetic branding customization not impacting on Safety and Performance requirements

3.1 DESCRIPTION OF COMMON USER'S INTERFACE

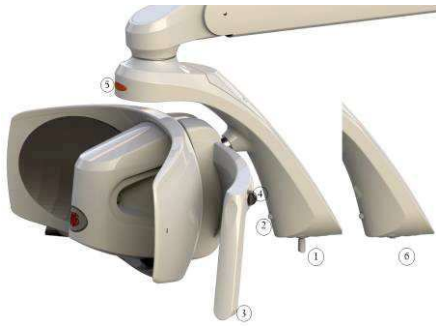

- | | |
|--|--|
| <p>1 Joystick
2 Button for pairing and Tk change
3 Sterilizable Handle</p> | <p>4 Knob of the handle
5 Indicator Strip
6 Sensor (alternative to Joystick)
7 Button for Theia Tech</p> |
|--|--|

4 INSTRUCTION FOR USE

The device must be cleaned before use (see Device Cleaning paragraph).

	<p>Caution</p> <p>Do not use the device in flammable or explosive environments Simultaneous use of the light with electro-surgical devices can cause malfunctioning (flickering, no command, etc)</p>
	<p>Warning</p> <p>The Joystick must be handled with care to avoid breakages. Never move the light using the switch to grip.</p>
	<p>Note</p> <p>At the switching on the device makes a self diagnosis, and the Indicator strip starts blinking with different colours: blue, green and red. The following parameters are memorized by the lamp and made available at every switching on:</p> <ul style="list-style-type: none"> • Last light intensity setting • light colour temperature Setting (for Tunable White variant)
	<p>Warning</p> <p>Do not use the device if parts or enclosures are damaged or plays or gaps appear between:</p> <ul style="list-style-type: none"> • Head Bow / Head Joint • Fixed Arm Joint / Swivel Arm Joint
	<p>Warning</p> <p>The joystick must be handled with care to avoid breakages. Never move the light using the joystick.</p>

4.1 SWITCHING ON/ OFF

Joystick

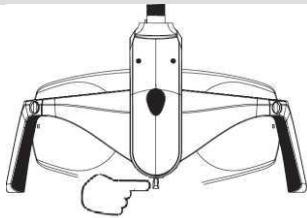

Push right or left and release
Acoustic signal: 1 beep

Sensor

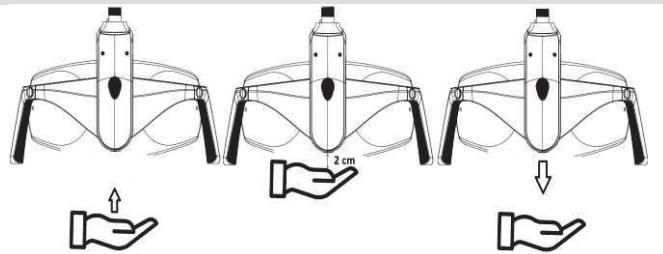

Bring the hand towards the sensor up to 2 cm and move the hand down
Acoustic signal: 1 beep

4.2 ADJUSTING THE LIGHT INSTENSITY

Joystick Increase Light Intensity

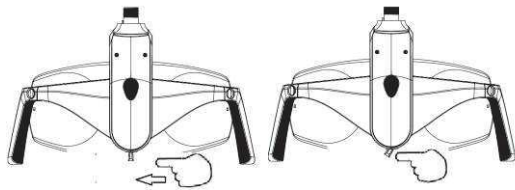

Push left and keep pushed until desired intensity is reached. Then release
Acoustic signal: 1 beep at command
Maximum intensity reached: continuous beep

Joystick Decrease light intensity



Push right and keep pushed until desired intensity is reached, then release.
Acoustic signal: 1 beep at command
Minimum intensity reached: continuous beep

Sensor - Increase and decrease light intensity

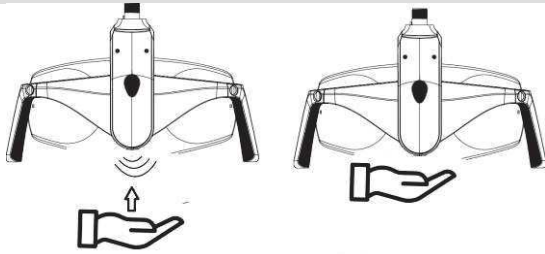

Bring the hand towards the sensor up to 2 cm and keep this distance until the desired light intensity is reached
 Acoustic signal: 1 beep at command
 Maximum intensity reached: 2 beeps
 Minimum intensity reached: 1 beep

i in sensor version the light intensity changes continuously decreasing until minimum and increasing until maximum

Note when changing the light intensity the indicator light changes according to the illuminance level, according to the images below:



4.3 CHANGING COLOR TEMPERATURE ON TUNABLE WHITE VERSION

Joystick and Sensor

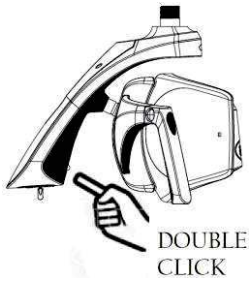





Every time a double click is performed, the Tk of the light changes.
 Repeat the procedure until the desired colour temperature is shown on the indicator light.
 2 beeps will inform the user that Tk is changing.

Sunlight Version	Tunable White Version		
TK 5000 K Green Luminous Indicator Strip	TK 4000 K Yellow Luminous Indicator Strip	TK 5000 K White Luminous Indicator Strip	TK 5700 K Blue Luminous Indicator Strip

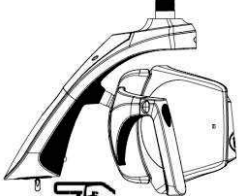
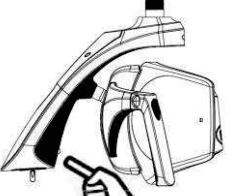
4.4 COMPOSAVE SETTING ON TUNABLE WHITE VERSION

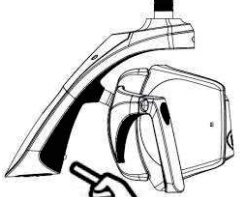
Composave setting allow the user to work with restorative material avoiding their polymerization. Select the composave setting as described below:

Joystick version option 1	Joystick version option 2	Visual information
 <p>Press and release</p>	 <p>SINGLE CLICK</p>	
Sensor version		Visual information
 <p>SINGLE CLICK</p>		





At the command selection of compo save a wigwag beep will be heard. Indicator strip changes in orange.



exit from the compo-save setting with a single click from Compo-save Setting

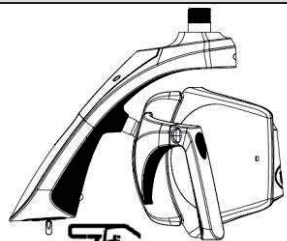
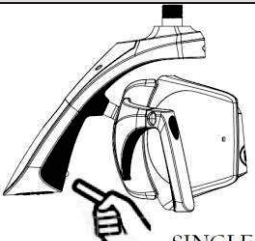

4.5 MINIMUM INTENSITY SETTING ON SOLAR VERSION

Joystick version	Sensor version	Visual Information
 <p>Press and release</p>	 <p>SINGLE CLICK</p>	

4.6 AUTO-ON SETTING

When the on-mode is set in on position the lamps turn on automatically (without a specific command from the user) when there is power supply.

4.7 SWITCHING ON/ OFF THEIA

	<p>The light on the fixed arm (secondary light) can be switched on/off and adjusted in synchro-mode with the operator light and its command. The secondary light can be manually operated using the button (7) on the fixed arm.</p> <p>If the secondary light is switched on after the operator light, it will be automatically synchronized.</p> <p>If the secondary light is switched on with the operator light switched off, it will be automatically settled at the maximum intensity.</p> <p> The light on the fixed arm is adjusted in synchro mode with head, it cannot be adjusted independently.</p>
--	--

4.8 REMOTE CONTROL

Make reference to the Dental Unit's instruction for use the Dental Light from the Dental Unit's control panel

4.9 SYNCRO MODE WITH FARO ROOM LIGHT

When present, the device can be connected by Radio Frequency (RF) connection to the Faro Room Light to create a synchronized lighting system.

The procedure to create this connection is called "pairing".

If more than one Room Lights are installed in the cabinet, take care that the other Room Lights are turned off or are turned on for more than 60 seconds.

To activate the "Pairing", proceed as follows:

1. Switch on the Faro Room Light. The Room Light will start Searching an input from the dental light for 60 seconds.

2. Within the 60 seconds, press the "Pairing" button on the dental lamp between 4 and 6 seconds. But not for more than 6 seconds (otherwise the procedure will be cancelled).

The Room Light activates the blue LED on the aluminium body.



If the blue LED does not switches on, it is possible another attempt (within the 60 seconds by the firsts). If 60 seconds past from the switching on of the Room Light, it is necessary to repeat the procedure from point 1.

3. After the blue LED switches on the room light, there are 60 seconds to confirm the "Pairing" by pressing the programming button placed on the remote control of the Room Light. At this point, the blue LED of the Room Light blinks at double frequency and then switches off. If the button on the remote controls is not pressed within 60 seconds, the blue LED switch off and the procedure must be repeated from point 1.

After the "Pairing", synchronization between the 2 lamps (dental light and room light) is enabled.

To DE-ACTIVATE THE SYNCHRONIZATION FUNCTION, proceed as follows:

Press the Synchro button from 2 to 4 second, then release it.

On release, a sound signal (Beep) will be heard and the blue LED on the Room Light lamp will go out to indicate that synchronization has been disabled.

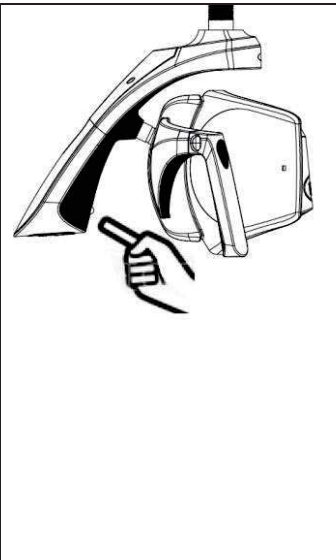

When the Faro Room Light is synchronized with the Dental Light the blue LED on the room light is lighted in steady mode. If the LED is off, the synchronization is not active.

The remote control is always enabled, so it is possible to change the illumination value in manual mode.

If the Dental Light is turned off, the room light will remain switched.

5 PREVENTIVE MAINTENANCE AND ROUTINE CHECKS



Only Service Engineer are allowed to perform corrective Maintenance and replacement of any part of the device, according to Manufacturer's Service Manual.

Checks	Frequency	Procedure	Responsible
No plays or space gaps between the junction points (points 1, 2, 3, 4)	Yearly		Service Engineer
Screws of connection points must be tightened and integer: <ul style="list-style-type: none"> screws 5 Screw 6. 	Yearly		Service Engineer
The nuts of connection points under carter 1, 2 must be well secured and safety screws intact. The screws under carter 3 must be well secured.	Yearly		Service Engineer
Check the absence of any oxidation into joints, arms or plastic parts.	Yearly	Visual inspection	Service Engineer
Check the main plate can be read	Yearly	//	Service Engineer
Check of damages on enclosure and plastic joints integrity.	Yearly		Service Engineer
Electrical Safety according EN 62353 1. Dielectric strength 2. Current Leakage	Every two years	Use the parameters defined into IEC 60601-1	Service Engineer
Light checks	Every two years	With a spectroradiometer check the values for: Max Luminance: >35000 lux CRI > 85 Radial power on blue light: <100 W/m ²	Service Engineer

6 CLEANING AND DISINFECTION

	<p>Warning against danger of wear and corrosion and falling suspended mass</p> <p>For all metal or plastic parts it is strictly forbidden to use substances that are</p> <ul style="list-style-type: none"> - abrasive, - corrosive, - acids, - substances containing chlorine or chloride ions, phosphorous or phosphorous ions, - detergents with Trilene base, petrol, white spirit, chlorine or similar. <p>Do not use detergents-disinfectants containing the following substances to clean plastic parts:</p> <ul style="list-style-type: none"> - Ammonium Hydroxide - Sodium Hydroxide - Hydrogen peroxide - Ammonium Chloride - Methylene chloride - Methyl alcohol - Acids and corrosive substances of all kinds. <p>It is forbidden to directly spray any chemical substance on the device. It is forbidden the use of wet wipes without rinsing.</p>
	<p>Faro tested and suggests the use of the following disinfectants, for plastic parts and metal parts:</p> <ul style="list-style-type: none"> - Durr FD366 Sensitive - Faro Perflex Advanced - Water-alcohol based disinfectants with 70% isopropyl alcohol or ethanol are suitable.

6.1 CLEANING OF THE REFLECTING PARABOLAS

Cleaning must be carried out using a soft cloth in cotton or absorbent cotton with ethyl alcohol.
Water-alcohol based disinfectants are suitable with 70% isopropyl alcohol or ethanol.

	<p>Caution - potential damage or wear on the parabolas</p> <p>Never spray detergent directly on the parabolas.</p> <p>Cleaning operations on the parabolas must be carried out wearing gloves, to avoid leaving fingerprints on the surfaces.</p> <p>Never use detergents containing surfactants or water-repellents that depositing can leave streaks. Slight streaking will not prejudice the quality of the light.</p> <p>Products differing from those suggested could damage the parabolas.</p> <p>If in doubt, contact FARO customer care.</p>
--	---

6.2 CLEANING AND DISINFECTION OF THE HEAD

Cleaning must be carried out using a soft cloth in cotton wetted with disinfectant solution.
Always squeeze the cloth to remove all the liquid in excess.

6.3 CLEANING AND DISINFECTION OF ARMS

Always use a cloth soaked in disinfectant approved to disinfect the surfaces and pass it over.
Always squeeze the cloth to remove all the liquid in excess.

7 STERILIZATION OF THE HANDLES

	<p>Warning - danger of cross contamination</p> <p>The handles are not supplied sterile, they must therefore be sterilised before use. The handles must be sterilised before each patient.</p>
---	--

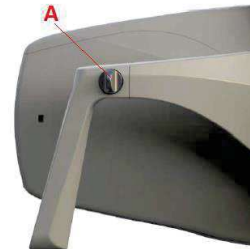

7.1 REMOVAL OF THE HANDLES

To remove the handle, unscrew knob "A" and remove it from the support.

7.2 DECONTAMINATION AND DISINFECTION

Before sterilising the handles, they must be decontaminated and disinfected.
To disinfect, Faro has tested the following products for disinfection:

- Faro Perflex Advance
- Durr FD366 Sensitive

	<p>WARNING - danger of plastic breaking</p> <p>The handles cannot be disinfected by thermo-disinfection.</p>
--	---

7.3 STERILIZATION

The handles must be packaged in compliance with EN 868-5.

The handles can be sterilised with standard cycles 121°/134° C up to two hundred (200) cycles or however up to loss of the mechanical performance.

The parameters of the sterilisation cycle are as follows:



Cycle EN 13060	Temperature	Pressure	Holding Time Minimum
B	121°C	207 kPa	15 min
B	134°C	308 kPa	3 min

8 TROUBLESHOOTING

8.1 ERROR LIST

Error	Description	Indicator Strip	Acoustic indication
E1	Open Led channel 1	First sector blinking. Colour set-up: RED	3 short beeps repeated 3 times
E2	OPL Open Led channel 2	First and second sectors blinking Colour set-up: RED	
E3	High temperature on the Led group	No	No
E4	Low or High input voltage	All sectors blinking together. Colour set-up: RED	5 lounge beeps
E5	Over Temperature Protection active	First sector blinking. Colour set-up: PURPLE	3 lounge beeps
E6	High temperature on the board	All sectors blinking sequentially. Colour set-up: PURPLE	3 lounge beeps

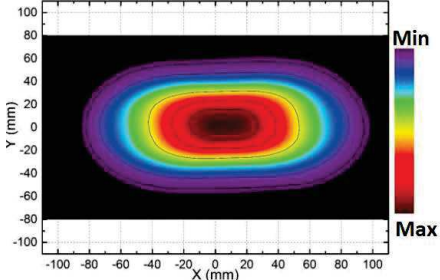
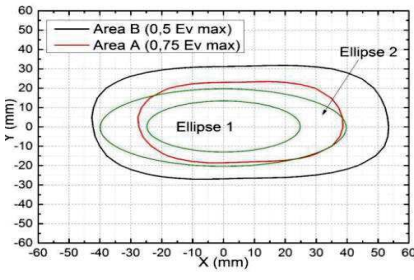
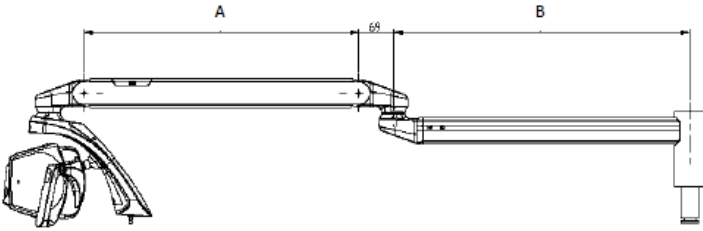
9 TECHNICAL SPECIFICATIONS

	Dental Light Dental Light Head	Dental Light with Theia Tech
Power Supply	24 V ac ±10% 50/ 60Hz; 32 V dc ±10%;	24V ac ±10% -50/60 Hz; 32 V dc ±10%;
Max Power :	24 V ac 26 VA 32 V dc 14 VA	24 V ac: 40 VA 32 V dc: 28 VA
Recommended fuses for installation (not supplied in charge to installation)	24 V ac T1.6AL 250V 32 V dc T1.25AL 250V	24 V ac: T2AL 250V 32 V dc: T1.25AL250V
Protection against electrical hazard	Class II Class I for Ceiling Mounting for Canada US Certification NB: final classification of the Protection Class of the Medical System is demanded to the Service Engineer in charge of installation or to the manufacturer	
Classification against IEC 62471	Class I - Labelling Exempt	
Max illuminance (*)	> 45.000 lux	
Color Rendering Index (*)	> 95	
Correlated Colour Temperature CCT (*)	Sunlight Version: 5.000 K Tunable White Versions: 4000 K – 5000 K – 5700 K Composave setting : 2700 K	
Spot Dimension (*)	180 mm x 110 mm	
Max Hard Shadow ISO 9680 (*)	10 mm x 5 mm	
Nature of the radiation	Non ionizing Radiation	
Type of radiation	Visible lights	
Typical illuminance Pattern ISO 9680		
Typical illuminance Pattern ISO 9680		
Overall Movements		
Head Rotations		

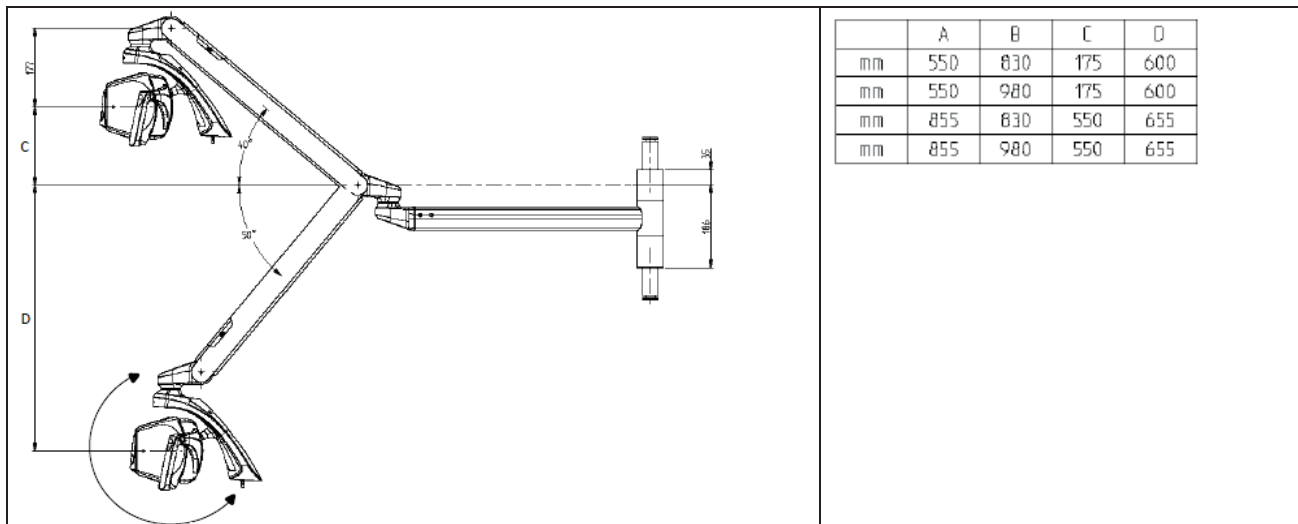

(*) Typical optical values subjected to tolerances

Measurement performed at 700 mm distance. Contact Faro for the correct procedure for the measurement.

9.1 STORAGE AND TRANSPORTATION: ENVIRONMENTAL CONDITIONS

The device in the original packaging can be transported and stored for a maximum period of 15 weeks if the following environmental conditions are met:

- Environmental temperature from -20°C to +70°C
- Relative humidity from 10% to 90%
- Atmospheric pressure from 50 kPa to 106 kPa

9.2 USE: ENVIRONMENTAL CONDITIONS

- The device must be used in the following environmental conditions:
- Temperature from 10° to 40°C
- Max altitude: 2000 m
- Relative humidity from 30% to 75%



DAL 1948: ESPERIENZA
E RINNOVAMENTO

 **FARO S.p.A.**

via Faro, 15 - 20876 Ornago (MB) - Italy
Tel. +39 039.68781 - Fax +39 039.6010540
www.faro.it - comm.italia@faro.it - export@faro.it

EVA

Dental Operating Light

Medical Device

Class I



FARO SpA si riserva il diritto di modificare, senza preavviso, le caratteristiche indicate nel presente manuale.
FARO SpA reserves the right to change the specifications of this equipment without notice.
FARO SpA se réserve le droit de modifier, sans préavis, les caractéristiques dans ce manuel.
FARO SpA behält sich recht vor, jederzeit stillschweigend technische oder bauliche Änderung vorzunehmen.
FARO SpA se reserva el derecho de modificar sin aviso previo la características incluidas en el presente manual de uso.